

Stamina[®]
POWER IDEAS



CATÁLOGO
promotional gifts
2021

TRENDING



Bienvenido a **powerideas** 2021

PROMOTIONAL GIFTS



El catálogo POWER IDEAS es la herramienta perfecta para encontrar tus ideas promocionales. Colección de artículos creada para inspirar y captar la atención de tu marca de forma efectiva en cualquier ocasión.

SERVICIO DE IMPRESIÓN

Ponemos a tu disposición un servicio exclusivo de marcaje para todos nuestros artículos. Con las más avanzadas soluciones de impresión. Ideales para tus campañas promocionales de marketing.

CUIDAMOS LA PRESENTACIÓN

Creemos en el primer impacto. Por eso, cuidamos la presentación de los artículos, diseños limpios y elegantes a la vez que respetuosos. Buscando siempre que la protagonista sea tu marca.

PROMOCIONES RESPONSABLES

Somos conscientes de la responsabilidad que tenemos de procurar un entorno más respetuoso para el beneficio propio y de nuestro planeta. Por ello apostamos cada día por nuevos materiales más ecológicos y que conllevan un proceso de producción menos agresivo con el medio ambiente.



UNA ELECCIÓN DE CONFIANZA



CALIDAD Y SOSTENIBILIDAD

Nuestro objetivo es siempre servir artículos de la más alta calidad de manera sostenible a un precio competitivo. Los artículos POWER IDEAS se evalúan cuidadosamente para que cumplan con los requisitos de seguridad, salud y medio ambiente de la UE.

SMETA  **SMETA 4 PILLARS**

Sedex  **SEDEX® MEMBERS**



AEO



OEKO-TEX STANDARD 100

OSC 100

(Estándar de Contenido Orgánico)



ILO

(Organización Internacional de Trabajo)



PEFC



ISO 9001: 2015



ISO 14001: 2015



OHSAS 18001: 2007



RoHS



+ antibacterial
ISO 22196

Encuentra los mejores regalos para resaltar tu marca

- 4 | GREEN IDEAS
- 36 | TECHNOLOGY
- 68 | WRITING & OFFICE
- 96 | BAG & TRAVEL
- 132 | WINTER & RAINY DAYS
- 140 | EATING & DRINKWARE
- 176 | GIFTS, PREMIUM & TOOLS
- 192 | SUBLIMATION
- 198 | PARTY & EVENTS
- 208 | SUMMER, LEISURE & SPORTS
- 226 | PERSONAL CARE
- 236 | SANITARY & PROTECTION
- 248 | CHRISTMAS





GREEN IDEAS

04/35



Una cuidada selección de artículos realizados con materiales ecológicos y reciclados sin renunciar al diseño y funcionalidad. Porque estamos convencidos de que entre todos podemos hacer un mundo mejor.

CARGADOR Y ALTAVOZ

Cuerpo de cemento y bambú



NEW

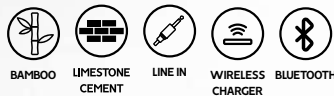

HELDENS_ 3209

Altavoz Bluetooth con base de carga inalámbrica y membrana visible. Cuerpo de cemento piedra caliza y superficie de bambú natural. Potencia altavoz 5W y salida inalámbrica de DC5V. Batería recargable. Cable incluido. Presentación en caja diseño eco.

11,8 x 7,8 x 6,5 cm 10 20

F(4), L2

| CEMENTO Y BAMBÚ

NEW



NEW

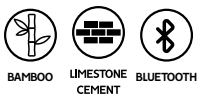

STEVE_ 3208

Altavoz inalámbrico con cuerpo de cemento piedra caliza y superficie de bambú natural. Bluetooth 5.0. Potencia 3W y batería recargable. Cable incluido. Presentación en caja diseño eco.

7,2x Ø7 cm

15

30

F(4), L2

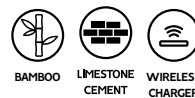

MARS_ 3021

Cargador inalámbrico con cuerpo de bambú natural y base de cemento piedra caliza. Coloque su smartphone sobre él y déjelo cargar. Compatible con modelos con tecnología inalámbrica. DC5V. Cable incluido. Presentación en caja diseño eco.

9,4 x 12,5 x 9,4 cm

15

30

E(4), L2

| LÍNEA BAMBÚ



NEW

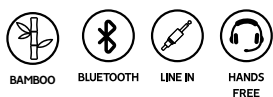

BAMBOO BLUETOOTH LINE IN HANDS FREE

KRAVIZ_ 3206

Altavoz inalámbrico con cuerpo de madera y membrana visible. Ideal para marcaje en láser. Bluetooth 3.0. Potencia 3W. Batería recargable. Cable incluido. Presentación en caja diseño eco.

6 x 6 x 6 cm 1 50

F(4), L1



BAMBOO USB

NEPTUNE_ 3023

Puerto USB con cuerpo de bambú natural y cable en blanco. Incluye 3 puertos USB. Presentación en caja de diseño eco.

8,5 x 1,6 x 4 cm 50 200

D(4), L1, W



NEW



BAMBOO WIRELESS CHARGER

GRAVITY_3022

Cargador inalámbrico con cuerpo de bambú natural. Coloque su smartphone sobre él y déjelo cargar. Compatible con modelos con tecnología inalámbrica. DC5V. Cable incluido. Presentación en caja diseño eco.

7 x 11,5 x 8 cm 25 50
E(4),L2



NEW



BAMBOO WIRELESS CHARGER

CORE_3024

Cargador inalámbrico de bambú natural integrado en bandeja organizadora. Compatible con modelos con tecnología de carga inalámbrica. DC5V. Cable blanco incluido. Presentación en caja diseño eco.

27 x 1,5 x 14,5 cm 1 20
E(4),L2,W



| LÍNEA BAMBÚ

NEW



ALESSO_3210

Altavoz inalámbrico Bluetooth con cuerpo de ABS, frontal de bambú natural y membrana visible. Incluye asa para transporte de polipiel. Potencia 3W. Batería recargable. Cable incluido. Presentación en caja diseño eco.

7,4 x 7 x 4,5 cm 25 50

E(4), L2



LUZ LED



HARDWELL_3207

Altavoz inalámbrico con cuerpo de ABS blanco y bambú natural. Función radio FM, manos libres, ranura para tarjetas micro SD y potencia 3W. Batería recargable. Cable incluido. Presentación en caja diseño kraft.

4,1 x Ø7,3 cm 1 50

F(4), L1



SOYUZ_3018

Cargador inalámbrico con cuerpo de ABS blanco y superficie superior de bambú natural. Coloque su smartphone sobre él y déjelo cargar. Compatible con modelos con tecnología inalámbrica. DC5V. Cable incluido. Presentación en caja diseño kraft.

1x Ø7,4 cm 50 200

E(4), L2, W



BLUES_ 3026

Auriculares inalámbricos bluetooth 5.0 con estuche de carga en bambú natural. Botón multifunción integrado en ambos auriculares. Función manos libres. Batería recargable. Cable incluido. Presentación en caja diseño eco.

7,8 x 3,2 x 3,2 cm 50 100
 E(4), L2

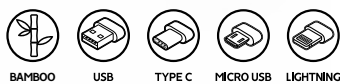

ASTRO_ 3019

Cable cargador 3 en 1. Cuerpo de ABS y bambú natural. Conexión Micro USB, Tipo C y Lightning. Presentación en bolsa eco con ventana.

16,5 x 1 x 2,1 cm 100 400
 D(1), L1



ROSSUM_ 3355

Batería externa de 5.000 mAh, con cuerpo de ABS blanco y superficie superior de bambú. Salida corriente USB DC5V/2.1A. Incluye cable Micro USB. Presentación en caja diseño kraft.

10,1 x 1,5 x 6,3 cm 25 50
 E(4), L2, W

LÍNEA, BAMBÚ



STOA_ 8034

Bolígrafo pulsador con cuerpo de bambú y accesorios en fibra de trigo / ABS. Tinta azul.

14,1x Ø1 cm 50 1000

B(4), L1

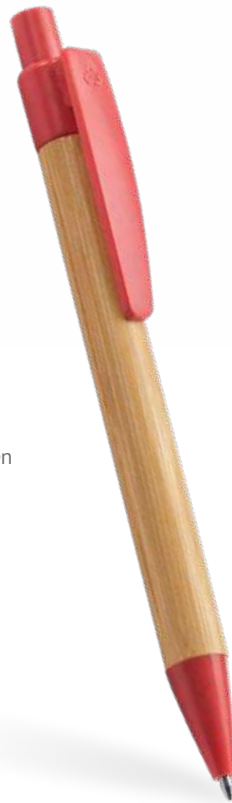

BAMBOO



TUCUMA_ 8018

Bolígrafo de bambú natural con accesorios de diseño en acabado plateado. Tinta azul.

13,9x Ø1,1 cm 50 1000

B(4), L1



SAGANO_ 8031

Bolígrafo con pulsador realizado en bambú. Carga Jumbo de tinta azul.

14x Ø1,3 cm 50 1000

B(1), L1



**KIOTO_ 8036**

Set Bolígrafo y Portaminas de bambú. Mecanismo pulsador. Tinta azul. Presentado en caja de cartón efecto madera.

17 x 2,2 x 4,1 cm 20 200

C(4), D(4), L1



PUNTERO TÁCTIL

BAMBOO

**PAMPA_ 8019**

Bolígrafo de bambú natural con clip metálico y puntero táctil. Carga jumbo de tinta azul.

14,8x Ø1 cm 50 1000

B(4), L1



01

60

05

226

02



METAL Y CORCHO



NATURAL
CORK

ARTUR_ 8044

Elegante bolígrafo metálico con acabado cromado y empuñadura de corcho. Presentado en estuche de corcho. Carga jumbo metálica de tinta azul.

13,9x Ø1,1 cm 1 200

D(1), L1



NEW



CORK

NEW



NATURAL
CORK

COMPER_ 8043

Bolígrafo con cuerpo de corcho y detalles en fibra de trigo. Tinta azul.

14x Ø1 cm 50 1000

A(4)

NEWNATURAL
CORK**VESPULA_7546**

Estuche de corcho natural con forro interior de poliéster y cremallera.

 23 x 11 x 2 cm  50  200

 E(1), L2

NATURAL
CORK**LIMOSA_7545**

Monedero de corcho natural con forro interior y cremallera. Incluye anilla para transporte.

 10 x 9 x 2 cm  100  800

 D(1), L2

NEW

FIBRA DE TRIGO



29 03 31 60 242 114



KAMUT_ 8035

Bolígrafo con pulsador realizado en fibra de trigo y ABS. Tinta azul.

13,8x Ø1 cm 50 1000
A(4)



LIKA_ 8025

Bolígrafo giratorio de fibra de trigo y PP con acabados en negro. Tinta azul.

14x Ø1,3 cm 50 1000
A(4)



CLIP ANCHO



JADE_ 8027

Bolígrafo con pulsador de fibra de trigo y ABS. Clip ancho especial para marcaje. Tinta azul.

13,6 x Ø1 cm 50 1000
A(4)

SOPORTE MÓVIL



LAURISILVA_ 8026

Bolígrafo con pulsador de fibra de trigo y ABS. Clip ancho especial para marcaje y función soporte. Tinta azul.

15x Ø1,1 cm 50 1000
A(4)

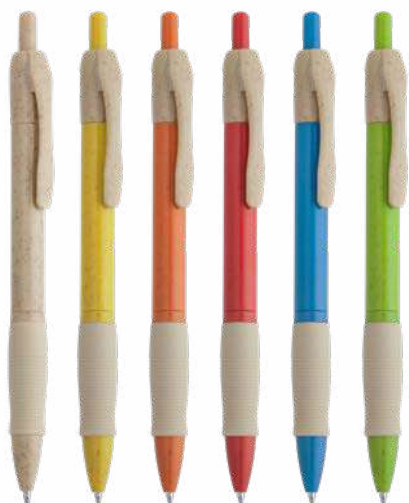

2929 0329 3129 6029 24229 11429



03 31 60 242 114 29



HANA_ 8032

Bolígrafo pulsador de fibra de trigo y ABS con cómoda empuñadura. Tinta azul.

14,5x Ø1 cm 50 1000 A(4)



HAYEDO_ 8030

Bolígrafo pulsador de fibra de trigo y ABS con acabados plateados. Tinta azul.

14,1 x Ø1 cm 50 1000 A(4)

CARTÓN RECICLADO

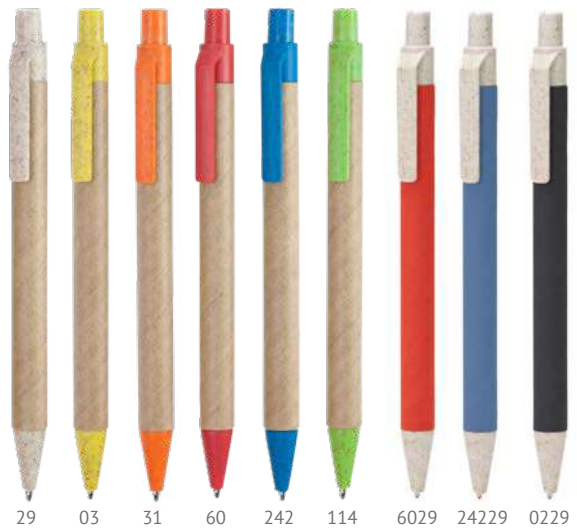

GROVE_ 8029

Bolígrafo pulsador hecho en cartón reciclado. Con la punta y el clip en fibra de trigo y ABS. Tinta azul.

14x Ø1 cm

50

1000

A(4)

NEW



LIANDE_ 8042

Bolígrafo de cartón reciclado con capucha. Tinta azul.

14,2x Ø0,8 cm

50

1000

A(4), W



100% PET RECICLADO

Fabricado a partir de plástico de botellas recicladas



49

31

03



ARASHI_ 8048

Bolígrafo marcador 2 en 1 con diseño translucido realizado a partir de material RPET. Bolígrafo de tinta azul. Marcador en colores fluor.

 14,6x Ø1,3 cm  50  1000

 A(4)

NEW



00

242



ARAL_ 8037

Bolígrafo de diseño translúcido realizado a partir de material RPET. Mecanismo pulsador. Tinta azul.

 14,1 Ø1 cm  50  1000

 A(4)



PACIFIC_ 8033

Bolígrafo de diseño translúcido realizado a partir de material RPET. Mecanismo pulsador. Tinta azul.

 14,2x Ø1,1 cm  50  1000

 A(4)



00

31

60

242

05

226

02



01 03 60



05 226 02



31 60 05

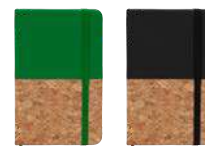

226 02



ESTELA_ 8070

Bloc de notas A5. Tapa rígida de cartón reciclado. Marcapáginas y banda elástica a color. 100 hojas.

14,7 x 21 x 1,5 cm 25 50

E(4)



CALES_ 8072

Bloc de notas A6. Tapa rígida de corcho natural. Marcapáginas y banda elástica. 80 hojas.

8,9 x 14 x 1,4 cm 50 100

E(4), L2



IRIS_ 8071

Bloc de notas A6. Tapa rígida mixta corcho / polipiel. Marcapáginas y banda elástica. 80 hojas.

9,3 x 14,3 x 1,5 cm 50 100

E(4), L2



31 60 05 226 02

ALANI_8073

Libreta con espiral y tapa rígida de cartón reciclado. Incluye bolígrafo a juego con tinta azul. 60 hojas.

16,5 x 21 x 1 cm 20 80
E(4)



60 05 226 02

LIEN_8074

Libreta con espiral y tapa rígida de cartón reciclado. Incluye bolígrafo a juego con tinta azul. 70 hojas.

9,7 x 14,4 x 1 cm 50 100
D(4), B(4)



SALER_8055

Libreta A6 de cartón reciclado. 60 hojas.

10,5 x 14,5 x 0,8 cm 20 200
E(1)

DANICA_8053

DANICA_8053

Libreta A5 de cartón reciclado. 60 hojas.

14,5 x 21 x 0,8 cm 10 100
E(1)

SALER_8055





01

60

40

31



02

03

05

226



PHOCA_7534

Bolsa reutilizable cosida de acabado laminado mate. Fabricada en resistente non-woven RPET 100 g/m² reciclado con asas reforzadas.

41 x 37 cm 10 250

F(1)

NEW



NEW



01

60

05

226



ORCA_7535

Bolsa reutilizable cosida de acabado laminado mate. Fabricada en resistente non-woven RPET 100 g/m² con asas reforzadas y ribetes a juego.

35 x 42 x 15 cm 10 200

F(1)



PLEGABLE



02 01 60 226 05

PANTALA_ 7549

Bolsa de la compra plegable realizada en suave poliéster reciclado 210T. Incluye práctico bolsillo para su plegado.

33 x 46 x 8 cm 20 400

F(1), G(1), R



05



60 226 01 02

LARUS_ 7550

Mochila de cordones realizada en suave poliéster reciclado 210D con esquinas reforzadas.

42 x 34 cm 50 300

F(1), R



NEW



05 02 60 01 226

ADAL_ 7544

Monedero con 2 bolsillos realizado en agradable polipiel RPET con cremalleras a juego. Incluye anilla llavero en el interior.

10,5 x 9 cm 10 500

D(1), L1



NEW



01 02 05 226 60

BUBO_ 7547

Neceser de dos compartimentos con cremalleras y cinta de transporte a juego. Realizado en poliéster reciclado RPET 210D.

21 x 13 x 8 cm 20 100

F(1), N(8), O

NEW



ASAS DE ALGODÓN



STERNA_ 7555

Bolsa de yute natural con asas en algodón de 70 cm.

44,5 x 35 x 14 cm 5 60

F(1)



YUTE NATURAL

NEW



TYTO_ 7560

Neceser de yute natural con cremallera a juego. Tirador de yute.

22 x 6,5 x 14 cm 10 200

F(1)



YUTE NATURAL



SIERRA_ 7558

Neceser multiusos realizado en algodón 180 g/m² y Yute. Cremallera con tirador de Yute a juego.

21,5 x 16 x 5 cm 10 200

E(1),N(8)



YUTE NATURAL



FRESH_ 9923

Cepillo dental con cuerpo realizado en bambú, con cerdas blancas de dureza suave. Presentación en caja diseño de cartón kraft.

17,5 x 1,6 x 1,3 cm 50 400

C(4),L1





YUTE NATURAL

**WAVE_ 7556**

Bolsa de la compra realizada en algodón 120 g/m² y Yute.
Con prácticas asas reforzadas de 70 cm.

41 x 37 cm

10

200

F(6), N(8), P

**WILKES_ 7557**

Mochila de cordones realizada en algodón
120 g/m² y Yute.

43 x 34 cm

10

100

F(6), N(8), O, P

YUTE NATURAL



100% ALGODÓN



ROLY

MIRLO_7137 

Mochila de cordones 100% algodón 140g/m². Cordones de 8mm. Etiqueta removible.

 34 x 42 cm

 10

 200

 F(6),N(8)



180 gr/m²

ZENITH_7551

Bolsa de la compra 100% de algodón 180 g/m² cosida. Con prácticas asas largas reforzadas de 70cm.

 41 x 37 cm

 50

 150

 F(4),N(8),P

140 gr/m²

HILL_7601 

Bolsa de la compra realizada en 100% algodón 140 g/m². Asas largas de 70cm.

 37 x 41 cm

 20

 200

 F(4),N(8),P

105 gr/m²

HILLOCK_7520

Bolsa de la compra 100% de algodón 105 g/m² cosida. Con prácticas asas largas reforzadas de 70cm.

 37 x 41 cm

 50

 250

 F(4),N(8),P



SOIL_ 7554

Bolsa de algodón 120 g/m². Un lado de la bolsa en diseño liso y otro lado en diseño rejilla. Cierre de cordón ajustable.

30 x 25 cm 50 250
F(4),N(8)

NEW



ARDEA_ 7552

Bolsa estilo saco de algodón 105 g/m² con cordones de autocierre.

15 x 21 cm 50 500
F(4), N(8)



LEAF_ 7553

Bolsa de la compra realizada en algodón 180 g/m² de abado liso y rejilla. Asas reforzadas de 60 cm.

45 x 42 cm 10 100
F(4),N(8)



DUNE_ 7525

Bolsa de la compra plegable 100% de algodón 105 g/m². Con asas largas de 70cm y cordón para plegado ajustable.

37 x 41 cm 10 200
F(4), G(4), N(8)

NEW

ASAS DE ALGODÓN



130 gr/m²

MILVUS_ 7561

Bolsa de resistente papel laminado con asas de algodón.

32 x 37,5 cm

1 250

F(1)



NEW



MILANA_ 7607

Nevera de papel laminado de diseño clásico, interior isotérmico de aluminio y solapa con cierre de cremallera. Incluye práctica asa para transporte.

19 x 13,5 x 14 cm

50

F(1)



NEW



60 226



05 03



SERRETA_ 7606

Bolsa nevera de papel laminado, con interior isotérmico de aluminio. Solapa con cierre de velcro y práctica asa para transporte a color.

20 x 25 x 10 cm

10 100

F(1)



BOLSAS DE PAPEL RECICLADO



MAPLE_ 7541

Bolsa de papel en acabado natural 110 g/m².
Asas cortas reforzadas en diseño rizado.

41 x 32 x 12 cm

200

F(1)



ROBLE_ 7540

Bolsa de papel en acabado natural 110 g/m².
Asas cortas reforzadas en diseño rizado.

32 x 40 x 12 cm

200

F(1)



HAYA_ 7539

Bolsa de papel en acabado natural 110 g/m². Asas
cortas reforzadas en diseño rizado.

22 x 23 x 9 cm

200

F(1)



ARCE_ 7538

Bolsa de papel en acabado natural 110 g/m².
Asas cortas reforzadas en diseño rizado.

25 x 31 x 11 cm

200

F(1)

420ml

NEW

coco_ 4081

Taza de cristal con tapa y cuchara de bambú. Capacidad 420 mL. Presentación en caja diseño eco.

9,5x Ø8 cm 1 36

F(1), C(4), L1



ECO BAMBOO 900ml

SAMBAL_ 4061

Fiambarrera de vidrio con tapa de bambú y banda de silicona. Capacidad 900 ml. Presentación en caja diseño eco.

20 x 6 x 15 cm 1 20

F(1), L2

NEW



BAMBOO 450ml

TRILBY_ 4020

Bidón de cristal de 450ml con tapón de bambú y cintra transporte de acabado natural. Presentación en caja diseño eco.

19,7 x Ø6,4 cm 1 50

F(1), L2

NEW

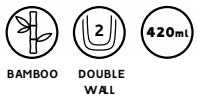

FENGI_4035

Termo de acero 304 doble pared y bambú. Capacidad 420 ml. Incluye cinta para transporte. Presentación en caja diseño eco.

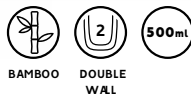

KINATA_4032

Bidón de acero inoxidable con doble pared. Pared exterior en bambú natural. Capacidad 500ml. Presentación en caja diseño eco.

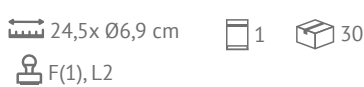

YABA_4033

Vaso de acero inoxidable 304 con pared exterior de bambú natural. Capacidad 500ml. Presentación en caja diseño eco.



NEW



SHAKE_4078

Abridor de diseño realizado en madera natural con interior de acero inox. Incluye troquel superior para colgar.





CHALA_ 4087

Posavasos de corcho natural.

0,3x Ø10 cm 10 1000
D(1), L2



NEW



NEW



SACHA_ 4057

Vaso reutilizable con capacidad 380 ml. Cuerpo de PP con recubrimiento de corcho natural.

8,5x Ø11 cm 1 40
C(1)



BERRY_ 4012

Taza de cerámica en acabado mate con tapa de bambú natural. Capacidad 370 ml. Presentación en caja de cartón Kraft.

10,5x Ø8,2 cm 1 36
F(1), L2



BAMBÚ

ACABADO MATE



CORCHO



ROSELLA_ 4013

Taza de cerámica con diseño en acabado mate y base de corcho natural. Capacidad 420 ml. Presentación en caja de cartón kraft.

11x Ø9 cm 1 36
F(1)



BUSTAN_ 4062

Vaso reutilizable de PLA con tapa enroscable y capacidad 450 ml.

13,4x Ø9,3 cm 1 50

F(1)



NEW

NEW



PARCHA_ 4063

Taza reutilizable de PLA con 350 ml. de capacidad.

8,8x Ø7,9 cm 50 100

E(4)



NEW



YOBO_ 4065

Fiamblera realizada en PLA con cinta de ajuste en silicona. Incluye Tenedor, cuchara y cuchillo. Capacidad 1 L.

19 x 11 x 8,5 cm 50 100

E(1)



NUTRI_ 4022

Vaso de papel 500ml. Capa interior de PLA. Biodegradable / Compostable.

13,4X Ø8,9 cm 50 1000

C(1)



TAPA ROSCA



YUZU_ 4018

Vaso con tapa a rosca de fibra de bambú y PP. Capacidad 460ml.

13,4X 9,3 cm 1 50
 E(1)



MIKAN_ 4016

Taza de 350ml en fibra bambú y PP.

8,8X Ø7,9 cm 50 100
 E(1)



2905



2960

2929

29226



NASHI_ 4017

Vaso con tapa de fibra bambú y PP. Banda de silicona. Capacidad 380ml.

11,2X Ø9,4 cm 10 100
 E(1)



ARECA_ 4019

Fiambarrera con cubiertos realizada en fibra de bambú y PP. Con cinta elástica para transporte. Capacidad 650ml.

16,6 x 5,1 x 11,2 cm 1 50
 E(1)



VOSTOK_ 5602

Poncho impermeable compostable. Con capucha y abertura para los brazos. Talla única adulto 127x102 cm. Fabricado en políácido láctico (PLA). Presentación en funda individual de PLA.

127 x 102 cm 50 200
E(1)

100% PET RECICLADO



MANGO MADERA

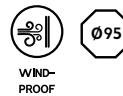
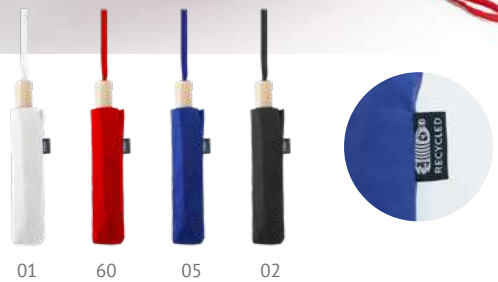

KHASI_ 5610

Paraguas plegable de poliéster reciclado 190T RPET con funda a juego. Bastón, varillas y terminaciones en negro. Mango de madera natural. Cierre con velcro a juego. y apertura manual.

27,5X Ø5,8 cm 1 50
G(1), N(8), L2



GRAN CAPACIDAD

Con 10000 mAh podrás cargar varios dispositivos a la vez



ESPECIAL PARA IMPRESIÓN DIGITAL



DOBLE SALIDA USB



0101

6001

0501

22601



ROBBIE_3352

Batería externa de ABS bicolor con 10000 mAh. Indicador de carga LED. Salida de corriente DC5V/2.1A. Incluye cable Micro USB. Presentación en caja diseño.

14,4 x 1,4 x 7,7 cm

10

40

E(4), W

BATERÍA EXTERNA INALÁMBRICA



WIRELESS
CHARGER

HAL_ 3353

Batería externa de ABS para carga inalámbrica con 5000 mAh. Función de fijación mediante ventosas. Indicador de carga LED. Salida corriente USB DC5V/2.1A. Inalámbrica DC5V/1A. Incluye cable Micro USB. Presentación en caja diseño.

10,4 x 6,5 x 1,6 cm 25 50

E(4), W

ESPECIAL PARA IMPRESIÓN



BENDER_ 3350

Batería externa de aluminio con capacidad 2600 mAh. Indicador de carga LED. Incluye cable con conexión USB y Micro USB. Presentación en caja diseño.

9,4 x 2,1 x 2,2 cm 25 100

D(4), L2



CARGADORES INALÁMBRICOS

NEW

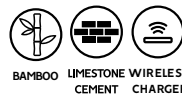

BAMBOO LIMESTONE WIRELESS
CEMENT CHARGER

MARS_3021

Cargador inalámbrico con cuerpo de bambú natural y base de cemento piedra caliza. Coloque su smartphone sobre él y déjelo cargar. Compatible con modelos con tecnología inalámbrica. DC5V. Cable incluido. Presentación en caja diseño eco.

9,4 x 12,5 x 9,4 cm 15 30

E(4), L2

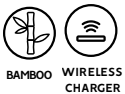
NEW

BAMBOO WIRELESS CHARGER

CORE_3024

Cargador inalámbrico de bambú natural integrado en bandeja organizadora. Compatible con modelos con tecnología de carga inalámbrica. DC5V. Cable blanco incluido. Presentación en caja diseño eco.

27 x 1,5 x 14,5 cm  1  20

 E(4),L2,W

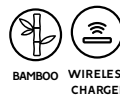
**NEW**

BAMBOO WIRELESS CHARGER

GRAVITY_3022

Cargador inalámbrico con cuerpo de bambú natural. Coloque su smartphone sobre él y déjelo cargar. Compatible con modelos con tecnología inalámbrica. DC5V. Cable incluido. Presentación en caja diseño eco.

7 x 11,5 x 8 cm  25  50

 E(4),L2



CARGADOR INALÁMBRICO BAMBÚ



ALUMINIO

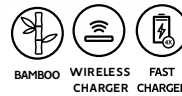

BAMBOO WIRELESS FAST
CHARGER CHARGER

FALCON_ 3005

Cargador inalámbrico con cuerpo en aluminio. Conecte el dispositivo, coloque su smartphone sobre él y déjelo cargar. Una luz le indicará que está cargando. Compatible con modelos con tecnología de carga inalámbrica. DC5V/1.0A. Cable incluido. Presentado en caja diseño.

0,7 x Ø9,8 cm 50 100
E(4), L2, W



BAMBOO WIRELESS FAST
CHARGER CHARGER

SOYUZ_ 3018

Cargador inalámbrico con cuerpo de ABS blanco y superficie superior de bambú natural. Coloque su smartphone sobre él y déjelo cargar. Compatible con modelos con tecnología inalámbrica. DC5V. Cable incluido. Presentación en caja diseño kraft.

1 x Ø7,4 cm 50 200
E(4), L2, W





WIRELESS
CHARGER

FAST
CHARGER

LANDER_ 3003

Base de carga inalámbrica para smartphone. Conecte el dispositivo, coloque su smartphone sobre él y déjelo cargar. Compatible con modelos con tecnología de carga inalámbrica. DC5V/1.0A. Cable incluido. Presentado en caja diseño.

1 x Ø7 cm

50

200

E(4), W



ALTAVOZ CARGADOR

Escucha música mientras cargas tu dispositivo



BLUETOOTH

WIRELESS
CHARGER

HANDS
FREE

LIGHT

MOLLER_ 3205

Altavoz Bluetooth con base de carga inalámbrica. Cuerpo de ABS retroiluminado. Conecte el dispositivo, coloque su smartphone y déjelo cargar mientras escucha su música favorita. Potencia altavoz 3W. Salida inalámbrica DC5V. Cable incluido. Presentación en caja diseño.

4 x Ø6,5 cm

50

100

F(4), W



60

05

02

CARGADOR PARA COCHE



WIRELESS CHARGER FAST CHARGER
HYDRA_3054

Soporte para smartphone con cargador inalámbrico para coche. Conecte el dispositivo, coloque el móvil sobre él y deje que se cargue. Compatible con modelos con tecnología de carga inalámbrica. Cable y 2 accesorios incluidos. DC5V/1.0A. Presentación en caja diseño.

2 ACCESORIOS

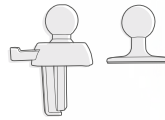

8,5 x 10 x 9,4 cm 1 50
E(1)



02



01

60

05

226

LANCER_3002

Cargador para coche en ABS con dos salidas USB. 2100 mAh. Presentación en caja blanca.

6,7 x 2,1 x 2,3 cm 50 500
C(4)



60

05

02

01

TARDIS_3000

Set Cargadores USB, coche y pared. Presentados en estuche de PU con cremallera. Velocidad de carga 1000 mAh.

8 x 4,2 x 6,3 cm 50 200
C(4), E(1)



IMÁN



ORION_ 3053

Soporte magnetico para coche. Realizado en aluminio y presentado en caja diseño.

3,3 x Ø3 cm 50 200
F(1), L1

SOPORTE MÓVIL

KETU_ 3020

Práctico tarjetero de silicona con función soporte para móvil. Incluye cinta adhesiva para adherirlo a la parte trasera de su móvil.

5,6 x 9,5 x 0,5 cm 100 500
L1



01 02 40 60 05 226 31 03



NOSTRO_ 3015

Soporte para móvil multifunción. Anillo giratorio 360°. Moneda para carro integrada. Adhesivo.

0,6 x Ø3,3 cm 200 1000
B(4)



01 60 05 226 02 03



ASTRO_3019

Cable cargador 3 en 1. Cuerpo de ABS y bambú natural. Conexión Micro USB, Tipo C y Lightning. Presentación en bolsa eco con ventana.

16,5 x 1 x 2,1 cm 100 400
D(1), L1

NEW

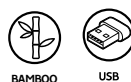

NEPTUNE_3023

Puerto USB con cuerpo de bambú natural y cable en blanco. Incluye 3 puertos USB. Presentación en caja de diseño eco.

8,5 x 1,6 x 4 cm 50 200
D(4), L1, W

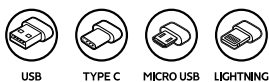

CRUX_3009

Cable cargador con llavero 3 en 1. Cuerpo en ABS de diseño plano ideal para marcaje. Conexión Micro USB, Tipo C y Lightning.

3,4 x 8,5 x 0,5 cm 100 500
C(4)

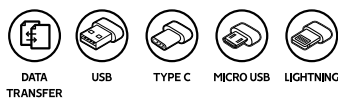
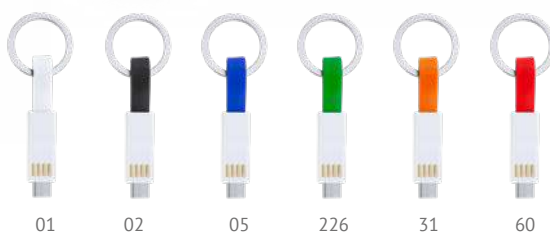

CETUS_3008

Cable cargador-sincronizador imantado con llavero 3 en 1. Conexión Micro USB, Tipo C y Lightning. Presentación en caja blanca.

1,2 x 6,7 x 1 cm 50 500
C(4)



GRABACIÓN LÁSER
TU MARCA SE
ILUMINARÁ

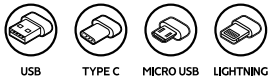

ARIES_3006

Llavero con cargador 3 en 1. Cuerpo de ABS en acabado metalizado retroiluminado mediante LED. Ideal para marcaje láser. Conexión Micro USB, Tipo C y Lightning.

1,5 x 13,5 x 1,5 cm 100 600
D(1), L1



SOPORTE

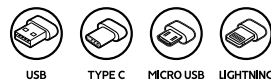
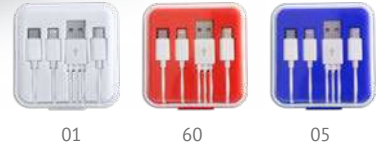

CANES_3007

Cable cargador 3 en 1. Presentado en un práctico estuche con soporte para smartphone integrado. Conexión Micro USB, Tipo C y Lightning.

6,7 x 6,8 x 3,3 cm 50 200
E(1), W



GORDON_3014

Adaptador de viaje universal. Europa, Asia, Reino Unido, USA, Australia. Presentación en caja blanca.

8,2 x Ø4,5 cm 50 100
D(4)



INDICADOR LED

BOPP_3013

Adaptador de viaje universal de diseño compacto y retráctil. Con acabado mate y tacto suave. Europa, Asia, Reino Unido, USA, Australia. 2 salidas USB. Velocidad de carga 2100 mAh. Presentación en caja blanca.

6,1 x 5,6 x 4,5 cm 50 100
D(4)

ALFOMBRILLA ESPECIAL SUBLIMACIÓN



6001



0101

0501

0202

SUBLIMACIÓN



01



03



60



05



226



02

JERRY_ 3052

Ratón plegable inalámbrico con sensor óptico de precisión. Diseño ergonómico con superficie en tacto goma. 2 Pilas AAA no incluidas. Presentación en caja blanca.

10,8 x 3,6 x 6 cm 50 100

E(1)

SIRA_ 3011

Alfombrilla para ratón de diseño plano. Superficie de suave poliéster y base antideslizante de silicona.

22 x 18 x 0,2 cm 100 200

E(1), R



258

02

05

60

01

TAPA WEBCAM

KASPER_ 3050

Tapa para cámara de dispositivo móvil o webcam. Con mecanismo deslizante y adhesivo 3M reutilizable.

3,2 x 1,3 x 0,1 cm

100

10000

B(1)

ACOLCHADO

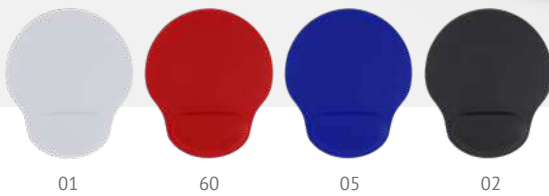

01

60

05

02



02



01

SILVANO_ 3012

Alfombrilla para ratón realizada en suave poliéster con reposamuñecas acolchado. Base antideslizante de silicona.

20,5 x 24,3 x 2 cm

1

100

E(1), R

STUART_ 3051

Ratón inalámbrico con sensor óptico de precisión y botón DPI integrado. Superficie con acabado en tacto goma. 2 Pilas AAA no incluidas. Presentación en caja blanca.

11,2 x 2,4 x 5,7 cm

100

200

E(4), W

TARIFA SEMANAL

SOLICITE NUESTRA TARIFA SEMANAL

Modelos con hasta 64Gb de capacidad. Modelos OTG, Conexión 3.0. Diseños personalizados en 2D y 3D.
Presupuestos en 24-48h.

Caja presentación estándar gratis

Servicio de grabación de ficheros

Color pantone especial gratuito
a partir de 500 unidades*
(*Consultar modelos disponibles)



ENTREGA RÁPIDA

En nuestro día a día, las entregas más rápidas se están convirtiendo cada vez más en una necesidad. Consulta nuestros modelos disponibles para entrega rápida.



CUMPLIMIENTO Y COMPROMISO DE CALIDAD

Por encima de todo, tus regalos siempre deben ser seguros. Por eso sólo utilizamos chips originales garantizando así la máxima calidad.



PERSONALIZA TU USB

Precios de tarifa con impresión a 2 colores o láser 1 posición incluida.



CANTIDADES PEQUEÑAS

Disfruta del modelo que más te guste desde tan sólo 100 unidades.

USB STOCK



16 GB 32 GB

MARVIN_ 4186

Memoria USB de diseño clásico con cuerpo de ABS y clip giratorio metálico. Presentación en caja de cartón blanco mate con ventana.

5,7 x 0,9 x 1,9 cm

50

300

D(4), L1



16 GB

CYLON_ 4187

Memoria USB de aluminio con diseño extraplano en forma de llave. Presentación en estuche metálico con ventana.

5,7 x 0,3 x 2,4 cm

1

200

D(4), L1



16 GB 32 GB

ROY_ 4188

Memoria USB metálica de diseño ultra compacto. Presentación en caja de cartón blanco mate.

3,8 x 0,4 x 1,2 cm

100

1000

D(4), L1



TECHNOLOGY

36/67



Últimas tendencias en tecnología, con nuevos materiales y acabados más responsables con el medio ambiente. Altavoces, cargadores, auriculares, relojes. No te lo puedes perder.



NEW

ALTAVOZ CARGADOR

CARGA INALÁMBRICA



- BAMBÚ
- LIMESTONE CEMENT
- LINE IN
- WIRELESS CHARGER
- BLUETOOTH

HELDENS_ 3209

Altavoz Bluetooth con base de carga inalámbrica y membrana visible. Cuerpo de cemento piedra caliza y superficie de bambú natural. Potencia altavoz 5W y salida inalámbrica de DC5V. Batería recargable. Cable incluido. Presentación en caja diseño eco.

11,8 x 7,8 x 6,5 cm 10 20
 F(4), L2

ALTAVOZ

NEW

- BAMBÚ
- LIMESTONE CEMENT
- BLUETOOTH

STEVE_ 3208

Altavoz inalámbrico con cuerpo de cemento piedra caliza y superficie de bambú natural. Bluetooth 5.0. Potencia 3W y batería recargable. Cable incluido. Presentación en caja diseño eco.

7,2 x Ø7 cm 15 30
 F(4), L2



NEW

BAMBOO BLUETOOTH LINE IN

ALESSO_ 3210

Altavoz inalámbrico Bluetooth con cuerpo de ABS, frontal de bambú natural y membrana visible. Incluye asa para transporte de polipiel. Potencia 3W. Batería recargable. Cable incluido. Presentación en caja diseño eco.

 7,4 x 7 x 4,5 cm  25  50

 E(4), L2

LÍNEA BAMBÚ

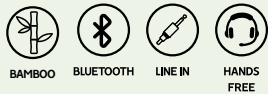

KRAVIZ_ 3206

Altavoz inalámbrico con cuerpo de madera y membrana visible. Ideal para marcaje en láser. Bluetooth 5.0. Potencia 3W. Batería recargable. Cable incluido. Presentación en caja diseño eco.

6 x 6 x 6 cm 1 50

F(4), L1



LUZ LED



HARDWELL_ 3207

Altavoz inalámbrico con cuerpo de ABS blanco y bambú natural. Función radio FM, manos libres, ranura para tarjetas micro SD y potencia 3W. Batería recargable. Cable incluido. Presentación en caja diseño eco.

4,1 x Ø7,3 cm 1 50

F(4), L1



TÁCTIL



0201

6001

5801

0501



VANDIK_ 3203

Altavoz inalámbrico Bluetooth 5.0 en acabado blanco con tacto goma. Combinación con tela a color. Panel de control táctil y luz LED multicolor en la base a ritmo de la música. Función manos libres. Potencia 3W. Batería recargable. Cable incluido. Presentación en caja diseño.

10,6 x 07,1 cm 1 50
F(1)



01

60

05

02



ARMIN_ 3204

Altavoz inalámbrico Bluetooth bicolor. Cuerpo en acabado mate de tacto goma. Asa de transporte, botones y tela a juego. Potencia 3W. Batería recargable. Cable incluido. Presentación en caja diseño.

11,1 x 8,3 x 4,1 cm 1 50
F(1), N(8)



ACABADO METALIZADO



GARRIX_ 3201

Altavoz inalámbrico con cuerpo metálico en acabado mate. Bluetooth 5.0. Función radio FM y manos libres. Potencia 3W. Batería recargable. Cable incluido. Presentación en caja diseño.

5 x Ø5,9 cm 25 50
 F(4)

ALTAVOZ CARGADOR



MOLLER_ 3205

Altavoz Bluetooth con base de carga inalámbrica. Cuerpo de ABS retroiluminado. Conecte el dispositivo, coloque su smartphone y déjelo cargar mientras escucha su música favorita. Potencia altavoz 3W. Salida inalámbrica DC5V. Cable incluido. Presentación en caja diseño.

4 x Ø6,5 cm 50 100
 F(4), W





RESISTENTE AL AGUA



VENTOSA



CALVIN_ 3202

Altavoz inalámbrico con cuerpo de ABS resistente a las salpicaduras de agua. Fijación mediante ventosa. Función manos libres. Potencia 3W. Batería recargable mediante cable Micro USB. Cable incluido. Presentación en caja diseño.

5,5 x Ø8,5 cm 1 50

F(1)

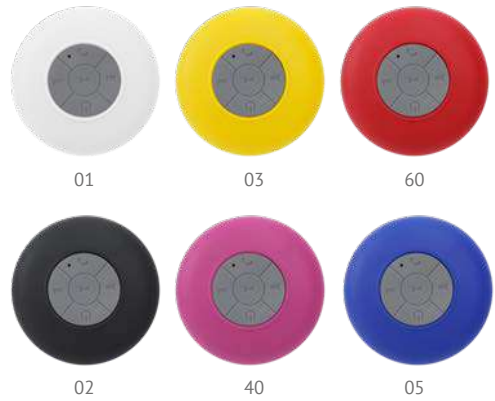

MICRO SD



COX_ 3200

Altavoz inalámbrico de ABS con acabado tacto suave. Bluetooth 5.0. Potencia 3W. Función manos libres. Batería recargable. Cable incluido. Presentación en caja diseño.

7,5 x Ø6 cm 1 50

F(4)



CÁMARA 4K

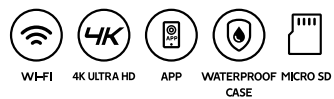

DISCOVERY_ 2100

Cámara deportiva con tecnología de vídeo HD 4K y conexión Wi-Fi. Pantalla LCD 2". Con función cámara de fotos Full HD 1080P. Incluye resistente carcasa sumergible hasta 30m y diversos accesorios de acople multifunción. Batería extraíble recargable. Cable incluido. Presentación en caja diseño.

6 x 4,2 x 3 cm 1 20

K(4)



BLUETOOTH LINE IN HANDS FREE RADIO FM STEREO SOUND MICRO SD

LEGRAND_ 3150

Auriculares inalámbricos Bluetooth 5.0 con acabado tacto goma. Plegables. Acolchado superior y almohadillas en suave polipiel. Laterales en aluminio ideales para marcaje en láser. Panel de control integrado con tecnología estéreo. Función manos libres y radio FM. Batería recargable. Cable incluido. Presentación en caja con fajín de diseño.

19 x 18,5 x 7,7 cm 10 20

F(1), L2



60 05 02 01



BLUETOOTH LINE IN HANDS FREE RADIO FM STEREO SOUND MICRO SD

RAYEL_ 3151

Auriculares inalámbricos Bluetooth 5.0 con panel de control integrado y tecnología estéreo. Plegables. Cómodas almohadillas de polipiel. Función manos libres y radio FM. Batería recargable. Cable incluido. Presentación en caja diseño.

19 x 17,5 x 8 cm 10 20

F(1)



ESTUCHE DE CARGA

NEW



BAMBOO BLUETOOTH HANDS FREE STEREO SOUND

BLUES_ 3026

Auriculares inalámbricos bluetooth 5.0 con estuche de carga en bambú natural. Botón multifunción integrado en ambos auriculares. Función manos libres. Batería recargable. Cable incluido. Presentación en caja diseño eco.

7,8 x 3,2 x 3,2 cm 50 100

E(4), L2



TECNOLOGÍA DE CARGA INALÁMBRICA



BLUETOOTH HANDS FREE STEREO SOUND WIRELESS CHARGE

TRAP_ 3025

Auriculares inalámbricos bluetooth 5.0 con estuche de carga. Botón multifunción integrado en ambos auriculares. Función manos libres. Batería recargable mediante tecnología inalámbrica. Cable incluido. Presentación en caja diseño.

7,5 x 3,2 x 3,2 cm 50 100

E(4), W

NEW



AURICULARES BLUETOOTH

Con práctico estuche de carga



BLUETOOTH HANDS FREE STEREO SOUND



FUNK_ 3307

Auriculares inalámbricos Bluetooth 5.0 con estuche de carga. Pantalla LED en el estuche y botón multifunción integrado en ambos auriculares. Función manos libres. Estuche con diseño en acabado mate y batería recargable. Cable incluido. Presentación en caja diseño.

6,2 x 2,8 x 4 cm 50 100

E(4), W



PANTALLA LCD



TÁCTILES



BLUETOOTH HANDS FREE STEREO SOUND

FERRY_ 3305

Auriculares inalámbricos Bluetooth 5.0 con estuche de carga. Elegante acabado en blanco brillante. Panel de control con tecnología táctil integrado en auricular. Función manos libres. Estuche con batería recargable y tapa imantada. Cable incluido. Presentación en caja diseño.

6,8 x 2,2 x 4,5 cm 50 100

E(4), W



MANOS LIBRES

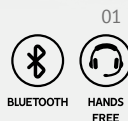

SAM_3304

Auricular individual inalámbrico con soporte USB magnético de carga. Batería recargable. Cable incluido. Presentado en un práctico estuche de PU con cremallera.

8 x 3,9 x 6,1 cm 1 200

E(1)

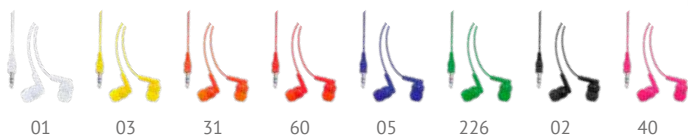

PUNK_3301

Auriculares presentados en práctica funda transparente de PVC con autocierre. Conexión Jack 3,5mm. Cable con botón de seguridad incluido.

8 x 7,8 x 1,2 cm 50 500

E(1)

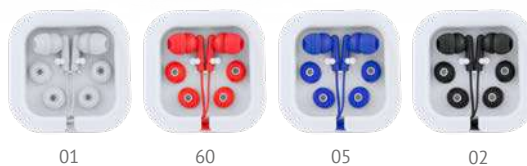

AOKI_3300

Auriculares en estuche de PS. Conexión Jack 3,5mm. Cable con botón de seguridad incluido. Incluye 3 pares de almohadillas de diferentes medidas.

7 x 7 x 2 cm 50 500

D(1), W

AURICULARES DEPORTIVOS



ACABADO METALIZADO MATE



FLUME_3303

Auriculares inalámbricos de aluminio con panel de control y micrófono incorporado. Imantado en los laterales. Sonido estéreo. Batería recargable. Cable incluido. Presentación en caja diseño.

7,5 x 13,6 x 3 cm 50 100

E(4)



60

02

05

251



01

02



KURA_3302

Auriculares inalámbricos con panel de control y micrófono incorporado. Sonido estéreo. Presentados en un práctico estuche de polipiel con cremallera. Batería recargable. Cable incluido.

3,9 x Ø8 cm 50 200

E(1), G(4)



SMARTWATCH DEPORTIVO



- 
HEART RATE
MONITOR
- 
CALORIES
COUNTER
- 
PEDOMETER
- 
SLEEP
CONTROL
- 
BLUETOOTH
- 
REMOTE
CAMERA
- 
APP
- 
NOTIFY

DRACO_ 3401

Reloj inteligente con funciones de actividad. Correa de TPU y pantalla a color TFT. Correa ajustable de silicona y hebilla metálica. Monitorización de frecuencia cardíaca. Conexión Bluetooth con APP para iOS y Android. Cable USB de carga incluido. Presentación en caja diseño.

 26 x 1,9 x 1,2 cm  50  100
 1(1), L2



WILLMAN_3402

Reloj inteligente con funciones de actividad. Correa de TPU y pantalla a color TFT 1,3" con USB de carga integrado. Correa ajustable de silicona y hebilla metálica. Monitorización de frecuencia cardíaca. Conexión Bluetooth con APP para iOS y Android. Presentación en caja diseño.

25 x 1,1 x 3,4 cm 1 50
 I(1), L2



FORNAX_3400

Reloj multifunción con pantalla LCD y correa ajustable de silicona. Pila botón incluida. Presentado en práctico estuche transparente ideal para marcaje.

25,5 x 2,7 x 1,5 cm 50 100
 E(1), F(1)

POWER BANK BAMBU



TIPO C



ROSSUM_ 3355

Batería externa de 5.000 mAh, con cuerpo de ABS blanco y superficie superior de bambú. Salida corriente USB DC5V/2.1A. Incluye cable Micro USB. Presentación en caja diseño eco.

 10,1 x 1,5 x 6,3 cm  25  50

 E(4), L2, W

LÍNEA LUZ

Tu logo se ilumina cuando está conectado



PANTALLA LCD

TIPO C



LIGHT UP

WALLE_ 3351

Batería externa en ABS de 5000 mAh. Acabado tacto goma con luz LED interior ideal para marcaje láser. Pantalla digital con indicador de carga. Salida de corriente DC5V/2.1A. Incluye cable Micro USB. Presentación en caja diseño.

9,4 x 6,2 x 1,3 cm 25 50

E(4), L2



02

60

05

55

226



GRABACIÓN LÁSER
LUZ

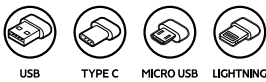

ARIES_ 3006

Llavero con cargador 3 en 1. Cuerpo de ABS en acabado metalizado retroiluminado mediante LED. Ideal para marcaje láser. Conexión Micro USB, Tipo C y Lightning.

1,5 x 13,5 x 1,5 cm 100 600

D(1), L1



01

60

05

226

02

antibacterial +





WRITING & OFFICE

68/95



Escribe y anota con estilo. Gran variedad de modelos en escritura y accesorios de oficina. Combinando diseño y sostenibilidad.

LOS MÁS POPULARES Y COLORIDOS



STIX_ 8010

Bolígrafo de ABS con pulsador en variada gama de colores. Tinta azul.

13,8 x Ø1 cm 50 1000

A(4)

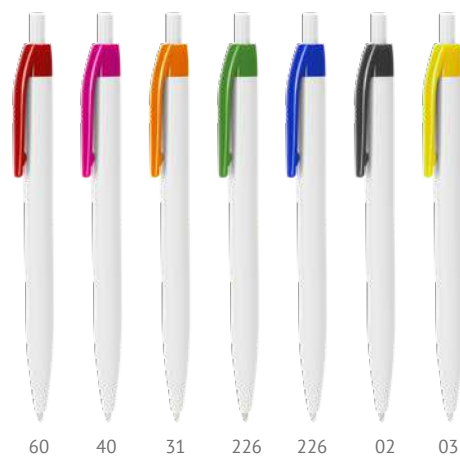

HINDRES_ 8045

Bolígrafo de ABS con pulsador. Cuerpo en color blanco y clip en variada gama de colores. tinta azul.

13,8 x Ø1 cm 50 1000

A(4)

+ antibacterial

ISO 22196

*Material tratado con Iones de Plata que evita la ploriferación de las bacterias.



antibacterial

ISO 22196

STARK_ 8040

Bolígrafo con cuerpo de ABS anti-bacterias. Tinta azul.
Norma ISO 22196.

 13,8 x Ø1 cm  50  1000

 A(4)



29 03 31 60 242 114



WHEAT
FIBER

KAMUT_ 8035

Bolígrafo con pulsador realizado en fibra de trigo y ABS.
Tinta azul.

 13,8 x Ø1 cm  50  1000

 A(4)

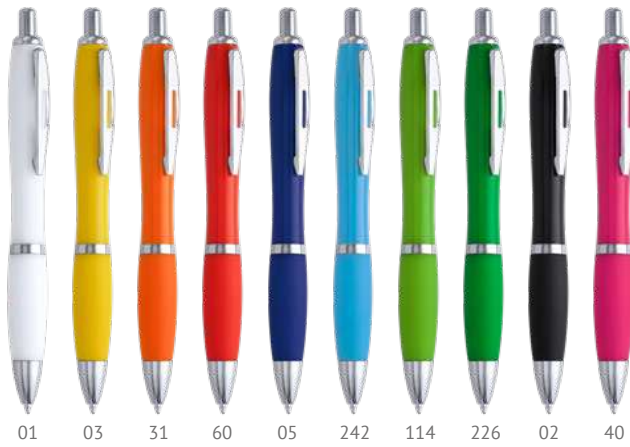

MERLIN_ 8009

Bolígrafo de ABS con pulsador y suave agarre. Tinta azul.

14 x Ø1,3 cm 50 1000
A(4)



anti**bacterial**
ISO 22196

CARREL_ 8039

Bolígrafo con cuerpo de ABS anti bacterias y suave agarre de color translúcido. Tinta azul. Norma ISO 22196:2011.

14 x Ø1,3 cm 50 1000
A(4)



+ antibacterial ISO 22196

*Material tratado con Iones de Plata que evita la ploriferación de las bacterias.



anti**bacterial**
ISO 22196

NEWTON_ 8038

Bolígrafo con cuerpo de ABS anti bacterias. Tinta azul. Norma ISO 22196:2011.

14 x Ø1,3 cm 50 1000
A(4)



GORBEA_8028

Bolígrafo con pulsador de fibra de trigo y ABS. Tinta azul.

14 x Ø1,3 cm 50 1000
A(4)

+ antibacterial

ISO 22196



01



05 02 60



antibacterial
ISO 22196



TOUCH
PEN

FARBER_8022

Bolígrafo higienizante antibacterias multifunción, con pulverizador recargable y puntero táctil. Capacidad 3 ml (líquido no incluido). Tinta azul.

16 x Ø1,5 cm 50 1000
B(4)

BAMBOO



SAGANO_8031

Bolígrafo con pulsador realizado en bambú. Carga Jumbo de tinta azul.

14 x Ø1,3 cm 50 1000
B(1), L1



251



29



TAIGA_ 8007

Bolígrafo giratorio en ABS con puntero táctil.
Acabado sólido. Tinta azul.

14 x Ø1,3 cm 50 1000

A(4)



CLIP ANCHO



SOPORTE MÓVIL

nature



LIKA_ 8025

Bolígrafo giratorio de fibra de trigo y PP
con acabados en negro. Tinta azul.

14 x Ø1,3 cm 50 1000

A(4)



JADE_ 8027

Bolígrafo con pulsador de fibra de trigo y
ABS. Clip ancho especial para marcaje. Tinta
azul.

13,6 x Ø1 cm 50 1000

A(4)



LAURISILVA_ 8026

Bolígrafo con pulsador de fibra de trigo y ABS.
Clip ancho especial para marcaje y función
soporte. Tinta azul.

15 x Ø1,1 cm 50 1000

A(4)

NEW



LIANDE_ 8042

Bolígrafo de cartón reciclado con capucha. Tinta azul.

14,2 x Ø0,8 cm 50 1000
A(4), W



NEW



COMPER_ 8043

Bolígrafo con cuerpo de corcho y detalles en fibra de trigo. Tinta azul.

14 x Ø1 cm 50 1000
A(4)

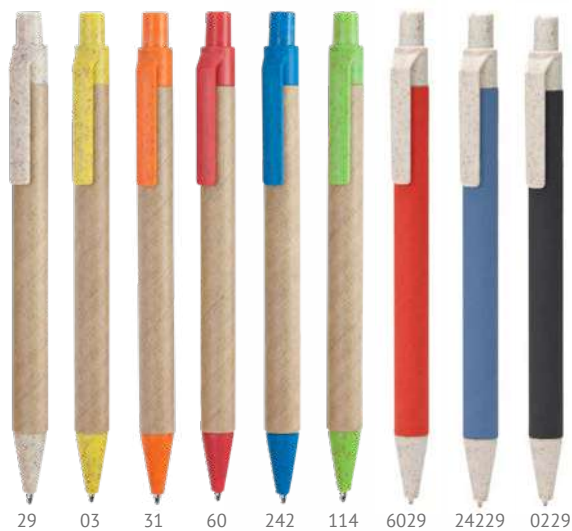

GROVE_ 8029

Bolígrafo pulsador hecho en cartón reciclado. Con la punta y el clip en fibra de trigo y ABS. Tinta azul.

14 x Ø1 cm 50 1000
A(4)



2929 3129 0329 6029 24229 11429



STOA_ 8034

Bolígrafo pulsador con cuerpo de bambú y accesorios en fibra de trigo / ABS. Tinta azul.

14,1x Ø1 cm 50 1000

B(4), L1

nature



TUCUMA_ 8018

Bolígrafo de bambú natural con accesorios de diseño en acabado plateado. Tinta azul.

13,9x Ø1,1 cm 50 1000

B(4), L1



PAMPA_ 8019

Bolígrafo de bambú natural con clip metálico y puntero táctil. Carga jumbo de tinta azul.

14,8x Ø1 cm 50 1000

B(4), L1



LÁPIZ

**KIOTO_ 8036**

Set Bolígrafo y Portaminas de bambú. Mecanismo pulsador. Tinta azul. Presentado en caja de cartón efecto madera.

17 x 2,2 x 4,1 cm  20  200

 C(4), D(4), L1

NEW**ARTUR_ 8044**

Elegante bolígrafo metálico con acabado cromado y empuñadura de corcho. Presentado en estuche de corcho. Carga jumbo metálica de tinta azul.

13,9x Ø1,1 cm  1  200

 D(1), L1

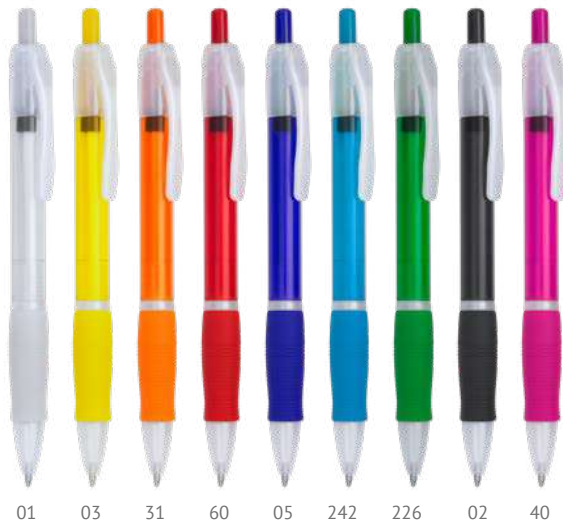

01 03 31 60 05 242 226 02 40

ONTARIO_ 8008

Bolígrafo con pulsador en acabado translúcido y cómoda empuñadura a juego. Tinta azul.

 14,5 x Ø1 cm  50  1000

 A(4)



natur e

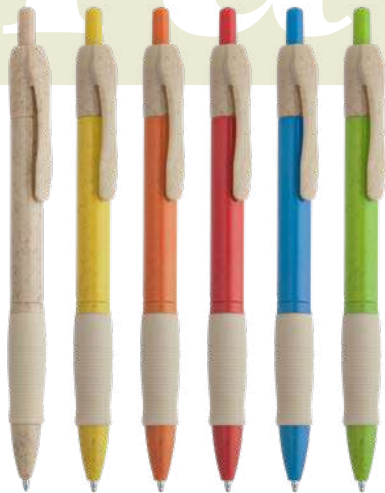

11429 24229 6029 3129 0329 2929



HANA_ 8032

Bolígrafo pulsador de fibra de trigo y ABS con cómoda empuñadura. Tinta azul.

 14,5 x Ø1 cm  50  1000

 A(4)

ESCRIBE CON CLASE

IRATI_ 8011

Bolígrafo giratorio de ABS en acabado brillo bicolor. Tinta azul.

14,5 x Ø1 cm 50 1000

A(4)



0201 0203 0231 0260 0205 02226



60 05 251 02

DORMITUR_ 8012

Bolígrafo giratorio de ABS en acabado metalizado. Tinta azul.

15 x Ø1,1 cm 50 1000

A(4)



31 60 05 226 251 02



TOUCH
PEN

SEMENIC_ 8006

Bolígrafo giratorio en ABS con puntero táctil. Acabado metalizado. Tinta azul.

13,5 x Ø1 cm 50 1000

A(4)



TOUCH
PEN

BORNEO_ 8014

Bolígrafo metálico con pulsador. Puntero táctil y clip de diseño. Carga Jumbo de tinta azul.

14,8 x Ø1 cm 50 500

B(4), L1



01 03 60 05 226 02



TOUCH
PEN

CANAIMA_ 8004

Bolígrafo giratorio de aluminio con puntero táctil. Tinta azul.

12,5 x Ø0,9 cm 100 1000

B(4), L1



01 03 31 60 05 226 02 40



TOUCH
PEN

BAUME_ 8005

Bolígrafo giratorio de aluminio con puntero táctil en color a juego con el cuerpo. Tinta azul.

13,7 x Ø0,7 cm 100 1000

B(4), L1



01 03 31 60 05 226 251 02

ARDENES_ 8013

Bolígrafo con cuerpo de aluminio y pulsador. En acabado anodizado. Carga Jumbo de tinta azul.

 13,7 x Ø1 cm  50  500

 B(4), L1



nature



HAYEDO_ 8030

Bolígrafo pulsador de fibra de trigo y ABS con acabados plateados. Tinta azul.

 14,1 x Ø1 cm  50  1000

 A(4)



+ antibacterial ISO 22196

*Material tratado con Iones de Plata que evita la proliferación de las bacterias.



HALLERBOS_ 8015

Bolígrafo con cuerpo de ABS anti-bacterias y puntero táctil. Clip metálico y carga jumbo de tinta azul. Norma ISO 22196.

 13,9x Ø1 cm  50  1000

 A(4)



BOLÍGRAFOS ROLLER

JAVARI_ 8016

Bolígrafo tipo roller con cuerpo de ABS y agarre acolchado. Clip y punta metálicos. Carga jumbo de tinta azul.

14,1 x Ø1,2 cm 50 500

A(4)



01 03 60 05 02



01 03 60 05 226 02

COLOMA_ 8017

Bolígrafo tipo roller con cuerpo en ABS en acabado tacto goma. Clip y punta metálicos. Carga jumbo de tinta azul.

14,3 x Ø1,1 cm 50 1000

A(4)



01

NEW

YAMA_ 8021

Bolígrafo tipo roller con clip metálico y detalles en acabado plata. Carga jumbo de tinta azul.

13,5 x Ø1,1 cm 50 1000

A(4)



05 03 02 01 60

100% PET RECICLADO

Fabricados a partir de plástico de botellas recicladas



ARAL_8037

Bolígrafo de diseño translúcido realizado a partir de material RPET. Mecanismo pulsador. Tinta azul.

14,1 x Ø1 cm 50 1000
A(4)

NEW



PACIFIC_8033

Bolígrafo de diseño translúcido realizado a partir de material RPET. Mecanismo pulsador. Tinta azul.

14,2 x Ø1,1 cm 50 1000
A(4)



ARAL_8037

Bolígrafo de diseño translúcido realizado a partir de material RPET. Mecanismo pulsador. Tinta azul.

14,1 x Ø1 cm 50 1000
A(4)



BOLÍGRAFOS MULTIHERRAMIENTA



KANCHAN_ 8024

Bolígrafo multiherramienta 4 en 1: nivel, regla en centímetros y pulgadas, destornillador con cabeza plana y estrella. Cuerpo con acabado metalizado, mecanismo giratorio y clip metálico. Tinta azul.

14,9 x Ø1 cm 50 1000
B(4)



NEW



NEW



ARAYA_ 8023

Bolígrafo linterna de luz LED con cuerpo de ABS metalizado. Mosquetón integrado en la capucha. Tinta azul.

11 x Ø1 cm 50 500
B(4)



ESTUCHE DE CORCHO

NEW



VESPULA_7546

Estuche de corcho natural con forro interior de poliéster y cremallera.

23 x 11 x 2 cm 50 200

E(1), L2

CORK



COLINA_7559

Estuche de acabado en colores lisos con cremallera a juego. Realizado en poliéster 600D.

22 x 11 cm 20 400

E(1), N(8), O



226

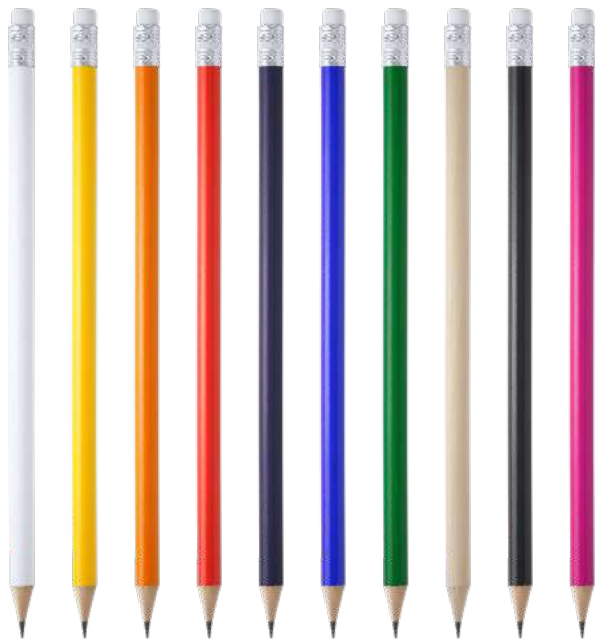

01 03 31 60 55 05 226 29 02 40

COUVET_ 8002

Lápiz de madera redondo con goma.

18,6 x Ø0,7 cm 100 2000

A(4), L1



MATA_ 8003

Minilápiz de madera en acabado natural con goma. Cuerpo redondo.

10 x Ø0,5 cm 100 2000

A(4)

+ antibacterial

ISO 22196

*Material tratado con Iones de Plata que evita la ploriferación de las bacterias.

NEW

GRYFIN_ 8046

Lápiz de madera con tratamiento antibacterias y goma disponible en varios colores.

18,6 x Ø0,7 cm 100 2000

A(4)



01 60 40 31 226 05 03

material



BOREAL_ 8000

Set de 6 ceras en caja de cartón reciclado.

5 x 8,3 x 0,8 cm 50 400

B(4), W



AMAZONIA_ 8001

Set de 6 lápices de madera en caja de cartón reciclado.

4,5 x 9 x 0,8 cm 25 500

B(4), W

NEW



DIBUJOS PARA
COLOREAR

TILOS_ 8049

Set infantil para colorear. Incluye bloc con dibujos, 6 lápices de colores y sacapuntas. Presentado en caja de cartón reciclado.

7,4 x 1,5 x 9 cm 50 400

C(4), W

NEW



LIZANA_ 8064

Set de 5 piezas presentas en estuche de cartón kraft. Incluye bolígrafo con cuerpo de cartón y tinta azul, lápiz de madera, sacapuntas, goma y regla de 15cm.

17,7 x 1,5 x 4,5 cm 50 400

B(4), W



29



01

NEW**DIMAS_ 8062**

Set de escritorio de cartón en forma de cubo compuesto por lapicero, bloc de notas (250 hojas) y 180 notas adhesivas en varios colores.

9 x 9 x 9 cm



1



40

D(2), W

NEW**BOSCO_ 8063**

Bloc de notas de diseño clásico con tapas de cartón reciclado. 200 hojas blancas. Incluye 125 notas adhesivas de distintos colores.

8,1 x 2,6 x 8,3 cm



50



100

D(2), W

**ANFI_ 8057**

Portanotas de anillas con original diseño en forma de bocadillo. Tapas rígidas de cartón reciclado. Incluye notas adhesivas en colores variados de dos tamaños: 100 grandes y 125 pequeñas.

8,3 x 10,7 x 2,3 cm



50



100

D(4)

**INNIS_ 8056**

Original portanotas de cartón reciclado con 100 notas adhesivas en 5 colores variados.

5,4 x 8,2 x 0,3 cm



100



500

C(4)

**ESTELA_ 8070**

Bloc de notas A5. Tapa rígida de cartón reciclado. Marcapáginas y banda elástica a color. 100 hojas.

14,7 x 21 x 1,5 cm 25 50

E(4)



01



03



60



05



226



02

**DANICA_ 8053**

Libreta A5 de cartón reciclado. 60 hojas.

14,5 x 21 x 0,8 cm 10 100

E(1)

**SALER_ 8055**

Libreta A6 de cartón reciclado. 60 hojas.

10,5 x 14,5 x 0,8 cm 20 200

E(1)



TAPAS EN CORCHO

El tacto de lo natural

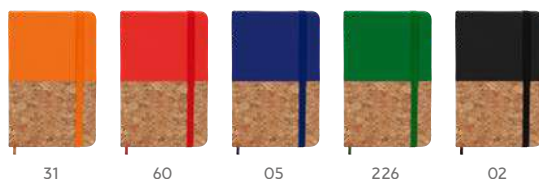

IRIS_ 8071

Bloc de notas A6. Tapa rígida mixta corcho / polipiel. Marcapáginas y banda elástica. 80 hojas.

9,3 x 14,3 x 1,5 cm 50 100

E(4), L2



CALES_ 8072

Bloc de notas A6. Tapa rígida de corcho natural. Marcapáginas y banda elástica. 80 hojas.

8,9 x 14 x 1,4 cm 50 100

E(4), L2





ALBA_ 8050

Bloc de notas A5 con tapa rígida de polipiel. Marcapáginas y banda elástica. 100 hojas.

14,7 x 21 x 1,5 cm 25 50
E(4), T



CORAL_ 8051

Bloc de notas A6 con tapa rígida de polipiel. Marcapáginas y banda elástica. 100 hojas.

9,3 x 14,3 x 1,5 cm 50 100
E(4), T

+ antibacterial
ISO 22196

*Material tratado con Iones de Plata que evita la ploriferación de las bacterias.

ELION_ 8061

Bloc de notas A6. Cubiertas de PU con tecnología antibacteriana. Marcapáginas y banda elástica. 80 hojas. Norma ISO 22196.

9 x 14 x 1,4 cm 50 100
E(4)



WATSON_ 8060

Bloc de notas A5. Cubiertas de PU con tecnología antibacteriana. Marcapáginas y banda elástica. 100 hojas. Norma ISO 22196.

14,9 x 21 x 1,3 cm 25 50
E(4)





31

60

05

226

02



ALANI_ 8073

Libreta con espiral y tapa rígida de cartón reciclado. Incluye bolígrafo a juego con tinta azul. 60 hojas.

16,5 x 21 x 1 cm 20 80

E(4)

CUADERNOS CON BOLÍGRAFO

El regalo perfecto para personas creativas

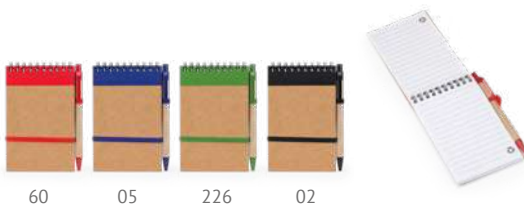

60

05

226

02



LIEN_ 8074

Libreta con espiral y tapa rígida de cartón reciclado. Incluye bolígrafo a juego con tinta azul. 70 hojas.

9,7 x 14,4 x 1 cm 50 100

D(4), B(4)





01

31

60

05

02

ARCO_ 8054

Mini libreta con espiral y tapa rígida de PP. 60 hojas de papel rayado. Incluye bolígrafo con tinta azul.

7 x 9,5 x 0,7 cm 50 300

D(4), B(4)

CUADERNOS DE PAPEL RAYADO



29

60

05

02

VALLE_ 8052

Libreta con espiral y hojas de papel rayadas microperforadas. Tapa rígida de cartón reciclado. 80 hojas.

16,4 x 21,7 x 1,6 cm 25 50

E(4)

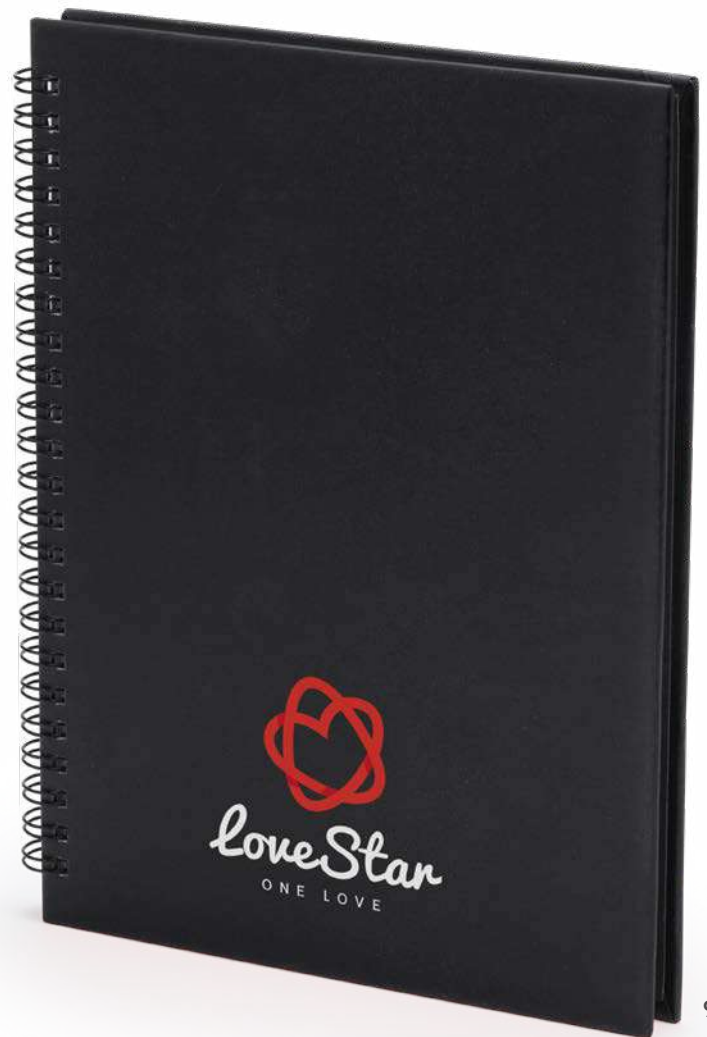

CALENDARIO PERPÉTUO

No tendrás que cambiar el calendario cada año



FENIX_8020

Calendario perpetuo de mesa realizado en PP.
Con espacio ideal para marcarje en tampografía.

14 x 9 x 4 cm 50 300
D(2)



CALENDARIO ALFOMBRILLA



SERBAL_3017

Alfombrilla para ratón con calendario 2021. Cubierta de PVC translúcida, hojas con espacio para notas y removibles. Base antideslizante.

23 x 18 x 0,4 cm 50 100
E(4)

AGENDAS 2022



HADES_ 8058

Agenda con cubierta de PU acolchada, grabada en bajo relieve. 320 páginas más 4 páginas con mapas. Marcador de páginas a juego con la portada.

17 x 24 cm  1  20

 E(1), T, U



HORUS_ 8059

Agenda tamaño A5 con cubierta de PU acolchada grabada en bajo relieve. 320 páginas más 4 páginas con mapas. Marcador de páginas a juego con la portada.

15 x 21 cm  1  20

 E(1), T, U



236



01 60 226 99 55 46 02 78

SEA_7504

Bolsa de non-woven 80g/m² termosellada con asas largas y fuelle hexagonal.

M11 44 x 30 x 10 cm

M13 54 x 40 x 10 cm 50 250

F(1)

60



01 226 99 02 31 03

LAKE_7503

Bolsa de non-woven 100g/m² termosellada con asas cortas.

35 x 40 x 12 cm 50 250

F(1)



01 55 57 02

56

RIVER_7502

Bolsa termosellada con diseño especial para botellas. Asa integrada en el cuerpo. Fabricada en non-woven 80g/m².

17 x 40 x 10 cm 50 500

F(1)

99



01 60 55 236 02

OCEAN_7501

Bolsa termosellada de non-woven 80g/m² con asa integrada en el cuerpo.

40 x 30 x 10 cm 50 400

F(1)



FOCHA_ 7523

Bolsa de la compra plegable en suave poliéster 190T. Variados diseños de frutas con cordón ajustable para cierre.

38 x 38 cm 10 400
F(1), G(1)



ALONDRA_ 7524

Bolsa de la compra plegable realizada en non-woven con cierre velcro y práctico bolsillo exterior. Asas cortas de 37cm.

38 x 42 cm 50 200
F(1), G(1), H(1)



TOCO_ 7522

Bolsa de la compra plegable en suave poliéster 190T en acabado cosido. Incluye práctico elástico para plegado.

42,5 x 38 x 7 cm 20 400
F(1), G(1), H(1), R



31

100% PET RECICLADO



02 01 60



226 05



PANTALA_7549

Bolsa de la compra plegable realizada en suave poliéster reciclado 210T. Incluye práctico bolsillo para su plegado.

33 x 46 x 8 cm 20 400

F(1), G(1), R



100% Recycled PET



NEW



01 60 40 31



02 03 05 226



PHOCA_7534

Bolsa reutilizable cosida de acabado laminado mate. Fabricada en resistente non-woven RPET 100g/m² reciclado con asas reforzadas.

41 x 37 cm 10 250

F(1)



01

60

05

226



ORCA_ 7535

Bolsa reutilizable cosida de acabado laminado mate. Fabricada en resistente non-woven RPET 100 g/m² con asas reforzadas y ribetes a juego.

42 x 35 x 15 cm 10 200

F(1)



NEW



60

05

31

226

02

01

COAST_ 7543

Bolsa reutilizable de acabado laminado brillante. Resistente PP woven 120g/m² con asas reforzadas de nylon y ribetes a juego en negro.

39 x 39 x 15 cm 20 100

F(1)

100% ALGODÓN



180 gr/m²

LEAF_ 7553

Bolsa de la compra realizada en algodón 180 g/m² de acabado liso y rejilla. Asas reforzadas de 60 cm.

45 x 42 cm

10

100

F(4),N(8)



120 gr/m²

SOIL_ 7554

Bolsa de algodón 120 g/m². Un lado de la bolsa en diseño liso y otro lado en diseño rejilla. Cierre de cordón ajustable.

30 x 25 cm

50

250

F(4),N(8)

BAGUETTE

**BAGUETTE_ 7519**

Bolsa 100% de algodón 105 g/m² cosida con clásico formato para el pan. Cierre de cordón grueso.

20 x 58 cm 10 500

F(4), N(8)

DUNE

**DUNE_ 7525**

Bolsa de la compra plegable 100% de algodón 105 g/m². Con asas largas de 70cm y cordón para plegado ajustable.

37 x 41 cm 10 200

F(4), G(4), N(8)

**NEW****ARDEA_ 7552**

Bolsa estilo saco de algodón 105 g/m² con cordones de autocierre.

15 x 21 cm 50 500

F(4), N(8)





ZENITH_7551



ZENITH_7551

Bolsa de la compra 100% de algodón 180 g/m² cosida. Con prácticas asas largas reforzadas de 70cm.

41 x 37 cm 50 150
 F(4), N(8), P



HILL_7601

Bolsa de la compra realizada en 100% algodón 140 g/m². Asas largas de 70cm.

37 x 41 cm 20 200
 F(4), N(8), P



HILLOCK_7520

Bolsa de la compra 100% de algodón 105 g/m² cosida. Con prácticas asas largas reforzadas de 70cm.

37 x 41 cm 50 250
 F(4), N(8), P

100% ALGODÓN



KNOLL_7521

Bolsa de la compra 100% de algodón a color 105g/m² cosida. Con prácticas asas largas reforzadas de 70cm.

 37 x 41 cm

 50

 250

 F(4), N(8), P



MOUNTAIN_7602

Bolsa de la compra 100% de algodón 140g/m² a color. Asas largas de 70cm.

 37 x 41 cm

 20

 200

 F(4), N(8), P



MILVUS_ 7561

Bolsa de resistente papel laminado de 130 g/m² con asas de algodón.

32 x 37,5 cm



250

F(1)



ASAS DE ALGODÓN



NEW

ASAS DE ALGODÓN



NEW



STERNA_ 7555

Bolsa de yute natural con asas en algodón de 70 cm.

44,5 x 35 x 14 cm



60

F(1)

YUTE NATURAL



WAVE_ 7556

Bolsa de la compra realizada en algodón 120 g/m² y Yute. Con prácticas asas reforzadas de 70 cm.

41 x 37 cm



200

F(6), N(8), P



YUTE NATURAL

BOLSAS DE PAPEL RECICLADO



MAPLE_ 7541

Bolsa de papel en acabado natural 110 g/m².
Asa cortas reforzadas en diseño rizado.

41 x 32 x 12 cm

200

F(1)



ROBLE_ 7540

Bolsa de papel en acabado natural 110 g/m².
Asa cortas reforzadas en diseño rizado.

32 x 40 x 12 cm

200

F(1)



HAYA_ 7539

Bolsa de papel en acabado natural 110 g/m².
Asa cortas reforzadas en diseño rizado.

22 x 23 x 9 cm

200

F(1)



ARCE_ 7538

Bolsa de papel en acabado natural 110 g/m².
Asa cortas reforzadas en diseño rizado.

25 x 31 x 11 cm

200

F(1)



01 31 60 05 226

TIBU_7603

Nevera con interior isotérmico de aluminio para 6 latas. Exterior en resistente PVC. Asa de transporte a juego y cierre de cremallera.

21 x 15 x 15 cm 25 200
F(1), N(8)



60 05 02

GRULLA_7605

Nevera multiusos de poliéster 600D. Compartimentos interiores isotérmicos y prácticos bolsillos exteriores. Cinta bandolera ajustable acolchada con mosquetón.

25 x 24 x 15 cm 1 20
G(1), N(8)



01 03 31 60

05 226 02 40

GRAJA_7604

Mochila nevera de cuerdas con interior isotérmico de aluminio. Exterior de poliéster 210D.

32 x 42 cm 10 200
F(1), N(8)

NEVERAS DE PAPEL

NEW

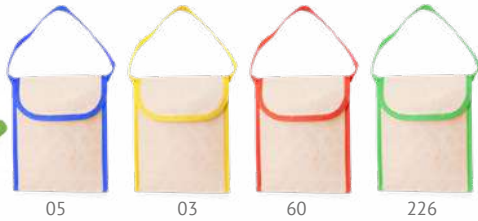

05

03

60

226



SERRETA_7606

Bolsa nevera de papel laminado, con interior isotérmico de aluminio. Solapa con cierre de velcro y práctica asa para transporte a color.

20 x 25 x 10 cm 50 100

F(1)



NEW



MILANA_7607

Nevera de papel laminado de diseño clásico, interior isotérmico de aluminio y solapa con cierre de cremallera. Incluye práctica asa para transporte.

19 x 13,5 x 14 cm

50

F(1)



A person is shown from the back, wearing a blue t-shirt and a blue drawstring bag. The bag has the text "I'm RECYCLED" printed on it in white. The person is standing in front of a wooden wall.

**I'm
RE
CY
CLED**



BAGS & TRAVEL

96/131



Diseño, confort y funcionalidad. Desde una gran diversidad de mochilas y bolsas de la compra hasta prácticos accesorios de viaje. Descubre muchos más regalos en esta sección.

CHUCAO



BOLSILLOS
LATERALES



58

243

255



CHUCAO_ 7146

Mochila para portátil de poliéster en acabado jaspeado. Tirantes, espalda y asa acolchadas. Doble compartimento frontal y bolsillos laterales. Etiqueta removible.

28 x 43 x 13 cm 1 15

Consultar

BOLSILLOS
LATERALES



231

60

55

15



DODO_ 7138

Mochila multifunción de poliéster 900D. Gran compartimento principal de apertura extensible con cremallera y ajustadores. Bolsillos laterales. Espalda y asas acolchadas. Etiqueta removible.

44 x 30 x 10 cm 1 10

Consultar



29

31

05

226

02

60

LORA_7515

Portadocumentos acolchado para portatil en suave poliéster 600D con bolsillo exterior. Asas de transporte a juego y cinta bandolera ajustable con mosquetón.

40,5 x 30 x 5,5 cm 1 50

F(1), N(8)

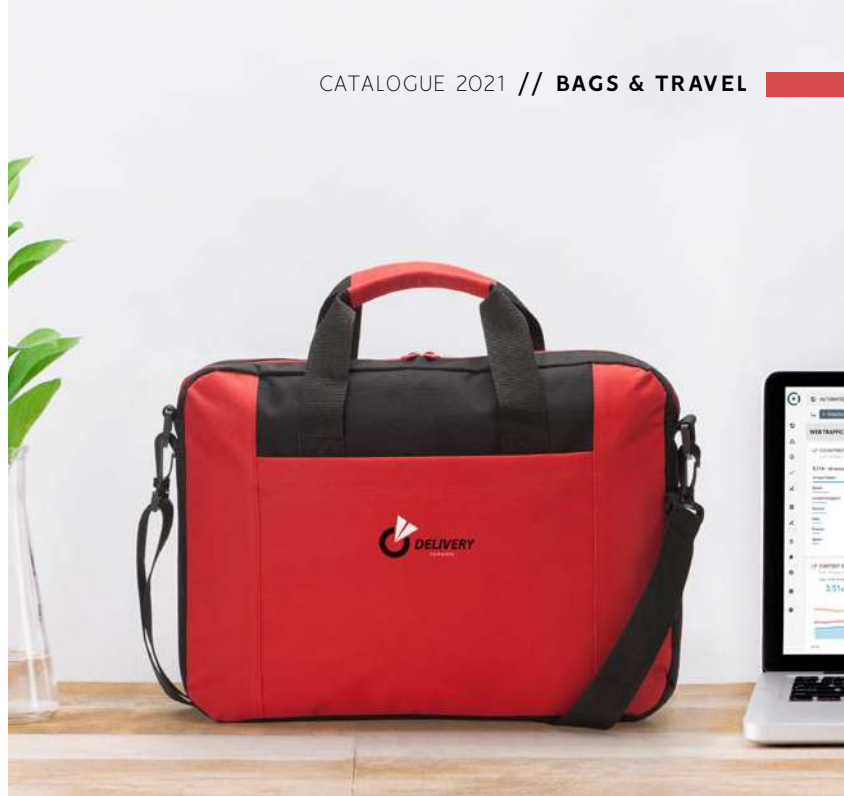

31



01

60

55

05

226

02

CHARRAN_7517

Portadocumentos de poliéster 600D en variados colores con asa de transporte y cremallera a juego.

40 x 29,5 x 5,5 cm 20 100

F(1), N(8)



60

55

05

02

LIBE_7516

Portadocumentos de poliéster 600D con un compartimento principal y cierre de cremallera. Ribetes con refuerzo y asa de transporte integrada en el diseño.

38 x 32 cm 20 100

F(1), N(8)



29

SIEMPRE CONTIGO

NEW

BOLSILLO TRASERO



VULTUR_7548

Riñonera de poliéster 600D con dos compartimentos, frontal y trasero. Cremalleras y tiradores a juego. Cinta ajustable.

25 x 17 x 8 cm 20 100

E(1), N(8)



60

GARZA_7518

Portadocumentos de viaje con cierre velcro y práctica asa para cinturón. Poliéster 600D

27 x 13 cm 40 400

E(1), N(8)



226

COLINA_7559

Estuche de acabado en colores lisos con cremallera a juego. Realizado en poliéster 600D.

22 x 11 cm 20 400

E(1), N(8), O



258

55

02

ANSAR_ 8201

Almohadilla inflable ideal para viajar con suave tacto antelina.

33 x 9 x 25 cm 20 200

F(1)



BRANTA_ 8200

Máscara de viaje realizada en suave microfibra. Doble elástico de ajuste.

18,5 x 9 cm 100 1000

D(1), N(8)



01

60

05

02

GORDON_ 3014

Adaptador de viaje universal. Europa, Asia, Reino Unido, USA, Australia. Presentación en caja blanca.

8,2 x Ø4,5 cm 50 100

D(4)



01

02

BOPP_ 3013

Adaptador de viaje universal de diseño compacto y retráctil. Con acabado mate y tacto suave. Europa, Asia, Reino Unido, USA, Australia. 2 salidas USB. Velocidad de carga 2100 mAh. Presentación en caja blanca.

6,1 x 5,6 x 4,5 cm 50 100

D(4)



96 57 05 86 02 38



COLIBRI_7510

Mochila de diseño urbano realizada en 70% poliéster 30% algodón. Compartimento principal de gran capacidad. Bolsillo frontal con cremallera a juego. Etiqueta removable.

28 x 36 x 11 cm 1 20

Consultar



256 248 246 135 243 252



TEROS_7145

Mochila clásica de poliéster 300D con acabado jaspeado. Bolsillo frontal con salida para cables. Espalda y tirantes acolchados. Detalles en negro. Etiqueta removable.

30 x 40 x 12 cm 1 20

Consultar



03 31 60 55 05
12 226 15 78 02



MARABU_7124

Mochila clásica con compartimentos de gran capacidad. Realizada en poliéster 900D. Espalda y tirantes acolchados. Etiqueta removable.

30 x 40 x 18 cm 1 20

Consultar



01 03 60



05 226 02



CONDOR_7153

Mochila de poliéster 600D con cierre de cremallera. Bolsillo frontal con salida para auriculares. Bolsillos laterales de diseño microperforado. Etiqueta removible.

30 x 40 x 18 cm 1 40

F(1), N(8), O



01 03 60 05



226 40 02



TUCAN_7158

Mochila clásica de resistente poliéster 600D. Compartimento principal y bolsillo frontal. Cierre de cremallera con tirador para fácil apertura. Espalda y asas acolchadas. Etiqueta removible.

28 x 38 cm 1 50

F(1), N(8), O, P



01 03 60 31



05 28 02 78



SISON_7154

Mochila ligera y compacta en resistente poliéster 600D. Bolsillo frontal de apertura vertical. Con acolchado en espalda y cintas de hombros. Etiqueta removible.

23 x 40 x 12 cm 1 50

F(1), N(8), O, R



100% ALGODÓN

Mochila de algodón natural



MIRLO



MIRLO_ 7137

Mochila de cordones 100% algodón 140 g/m².
Cordones de 8mm. Etiqueta removible.

34 x 42 cm

10

200

F(6), N(8), O, P



YUTE NATURAL



WILKES_ 7557

Mochila de cordones realizada en
algodón 120 g/m² y Yute.

43 x 34 cm

10

100

F(6), N(8), O, P



60



226



01



02



05



LARUS_ 7550

Mochila de cordones realizada en suave poliéster reciclado 210D con esquinas reforzadas.

42 x 34 cm

50

300

F(1),R





CUANCA_ 7150

Mochila de cordones con ojales metálicos. Realizada en poliéster 210D. Bolsillo frontal de diseño microperforado con cierre cremallera y salida para auriculares. Etiqueta removible.

34 x 43 cm 10 200
F(1), N(8)



NINFA_ 7152

Mochila de cordones con esquinas reforzadas realizada en poliéster 210D. Bolsillo frontal con cremallera y salida para auriculares. Etiqueta removible.

34,5 x 45 cm 10 200
F(1), N(8), R



ROLY**NEW**

01

60

05

55

02

**ZORZAL_ 7157**

Mochila deportiva de diseño plano y fácil personalización. Cordones planos a tono. Bolsillo interior con cremallera. 100% Polyester 600D. 150 g/m²

 35,5 x 42,5 cm  5  200

 Consultar



01 03 31 60



05 226 02 78



KAGU_7155

Mochila de cordones gruesos a juego realizada en poliéster 210T. Cordones de 8mm. Etiqueta removible.

35 x 45 cm 10 200

F(1), N(8), R



63 78 55



01 03 31 60



05 20 02 48



HAMELIN_7114

Mochila de cordones con ojales metálicos realizada en poliéster 210D. Etiqueta removible.

34 x 42 cm 50 300

F(1), N(8), R





0102 3102 6002 5502



9902 22602 0202 7802



01 03 31 60



05 226 02 78

GAVILAN_ 7509

Mochila de cordones de non-woven 70g/m² en diseño bicolor efecto metalizado.

34 x 42 cm 50 300

F(1)

CALAO_ 7151

Mochila de cordones con ojales metálicos realizada en non-woven 80g/m². Etiqueta removible.

36 x 42 cm 10 300

F(1)



991



992



993

MILANO_ 7526

Mochila de cordones en poliéster 190T. Con diseños deportivos.

43,5 x 43 cm 50 300

F(1)

2 TAMAÑOS

Kids



55

Kids

05

Kids

02

Kids



STRIKER_7111

Mochila deportiva de poliéster 600D con zapatillero. Doble fondo reforzado y base con tacos de fácil limpieza. Incluye cinta ajustable para transporte. Etiqueta removible.

44 x 45 x 27 cm



36 x 37 x 27 cm



Consultar



60

55

02

05

232



HIKER_7113

Mochila deportiva de poliéster 900D con bolsillo zapatillero. Doble compartimento frontal y bolsillos laterales con rejilla. Capacidad 26L.

32 x 46 x 18 cm



Consultar



PROLY



60

05

02

72



TURBO_7112

Bolsa de diseño cilíndrico en poliéster 600D con asas de nylon. Bolsillo lateral con cremallera. Capacidad 33L. Etiqueta removible.

28 x 56 cm



1



20

Consultar



PLEGABLE



02

252

58



FOLD_7116

Bolsa de diseño cilíndrico realizada en poliéster tafetán 125g/m². Con doble asa y bolsillo para plegado. Capacidad 12L. Etiqueta removible.

50 x 25 x 25 cm



1



50

Consultar



0258



4658



78252



JOGGER_7117

Bolsa combinada de poliéster 300D. Con doble asa ajustable y base reforzada. Bolsillo lateral con cremallera invertida. Capacidad 20L. Etiqueta removible.

42 x 27 x 27 cm



1



20

Consultar

NECESER 100% RPET

NEW



01



02



05



226



60



BUBO_ 7547

Neceser de dos compartimentos con cremalleras y cinta de transporte a juego. Realizado en poliéster reciclado RPET 210D.

21 x 13 x 8 cm 20 100

F(1), N(8), O

100% NATURAL



TYTO_7560

Neser de yute natural con cremallera a juego.
Tirador de yute.

22 x 6,5 x 14 cm 10 200

F(1)

YUTE NATURAL



NEW



YUTE NATURAL



SIERRA_7558

Neser multiusos realizado en algodón 180 g/m² y Yute. Cremallera con tirador de Yute a juego.

21,5 x 16 x 5 cm 10 200

E(1),N(8)



2929

2905

29226

2902



DOEL_7537

Neser multiusos de algodón 280 g/m² con acabado bicolor. Cremallera con tirador de algodón a juego.

22,5 x 17 x 5,5 cm 50 300

E(1),N(8)



2960

NECESER DE VIAJE



29

PARDELA_ 7513

Neceser de poliéster 600D con cremallera y práctica asa de transporte.

20 x 9,8 x 8,3 cm  10  200

 E(1), N(8), O



31

60

55

05

56

02



29

31

60

05

02

40

YUBARTA_ 7514

Neceser de poliéster 600D. Cremallera con tirador a juego.

22 x 14 x 6 cm  10  300

 E(1), N(8), O

ESPECIAL AEROPUERTOS



5 ACCESORIOS

ARNOLD_ 9935

Neceser de viaje transparente realizado en PVC con cierre hermético. Incluye surtido de prácticos botes ideales para gel, champú y perfume.

19 x 19 cm 1 100
E(1)



03



60



01

31

60

05

226

40

CARIBU_ 7511

Neceser con cierre hermético de PVC translúcido.

17 x 13 x 5 cm 50 400
E(1)



05

226

258

02

GRUS_ 7512

Neceser de poliéster 300D a color en acabado vigoré y PVC transparente. Con cremallera y práctica asa de transporte.

23,5 x 18,5 cm 100 200
E(1)

I FABRICADOS EN CORCHO



NATURAL
CORK

LIMOSA_ 7545

Monedero de corcho natural con forro interior y cremallera. Incluye anilla para transporte.

10 x 9 x 2 cm 100 800

D(1), L2



NEW

NEW



NATURAL
CORK

VESPULA_ 7546

Estuche de corcho natural con forro interior de poliéster y cremallera.

23 x 11 x 2 cm 50 200

E(1), L2



NEW



ADAL_7544

Monedero con 2 bolsillos realizado en agradable polipiel RPET con cremalleras a juego. Incluye anilla llavero en el interior.

10,5 x 9 cm 10 500
 D(1), L1

NEW



MEDEA_7542

Monedero realizado en agradable polipiel con cremallera a juego. Incluye anilla llavero en el interior.

10,5 x 7,5 x 0,5 cm 20 1000
 D(1), L1



995



996



997



998

ELANIO_7528

Mochila infantil de cuerdas plegable en poliéster 190T. Bolsillo para plegado con diseños de animales.

26,5 x 32,5 cm 10 500

F(1), G(1)



PACHU_9131

Delantal infantil de non-woven con diseño para colorear. Incluye 5 ceras en varios colores. Talla única ajustable.

43 x 43 cm 50 200

F(1)



AZOR_7529

Bolsa infantil de non-woven con diseño para colorear. Incluye 5 ceras en colores variados.

20,5 x 22 cm 50 100

F(1)



TURCAZ_7530

Mochila infantil de cuerdas realizada en non-woven. Con diseño para colorear. Incluye 5 ceras en colores variados.

25 x 30 cm 50 200

F(1)

CERAS INCLUIDAS

NON WOVEN

Material no tejido



CREST_ 7506

Bolsa de non-woven 80g/m² con asas largas de 70cm. Acabado termosellado.

36 x 40 cm 25 250

F(1)

TERMOSELADO



ESPECIAL SUBLIMACIÓN

MITO_ 7527

Bolsa de la compra en non-woven cosido con asas reforzadas. Ideal para sublimación. Asas de 70cm.

36 x 40 cm 50 250

F(1), N(8), R

COSIDO







WINTER & RAINY DAYS

132/139



Variedad de tejidos seleccionados para un mayor confort y libertad de movimiento. Artículos para la lluvia y el frío que no te dejarán indiferente.

DÍAS DE LLUVIA



MANGO ACOLCHADO



SUBLIMACIÓN



55

60

02

05

01



WIND-
PROOF



Ø130

HARUL_ 5609

Paraguas XL de poliéster 190T con mango, bastón y terminaciones en negro. Varillas largas de fibra de vidrio con sistema antiviento. Botón de apertura automática. Mango de EVA. Cierre con velcro a juego.

98 x Ø130 cm 1 25

G(1), N(8), R



MANGO MADERA

SUBLIMACIÓN

SUBLIMACIÓN

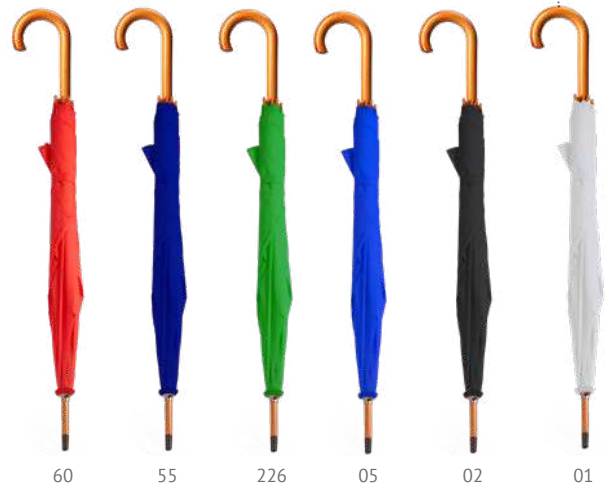

MILFORD_ 5608

Paraguas con tela y mango a juego. Varillas y terminaciones en negro. Cierre con velcro y apertura automática. Fabricado en poliéster 190T.

83 x Ø105 cm 1 25

G(1), N(8), R



LYSE_ 5607

Paraguas con mango, bastón y terminaciones en madera. Varillas en negro. Cierre con velcro a juego. Apertura manual. Fabricado en poliéster 190T.

90 x Ø105 cm 1 25

G(1), N(8), R



SUBLIMACIÓN



01 60 40 31 226 05 03 02



YAKU_ 5606

Paraguas plegable de apertura manual con funda a juego. Mango, varillas y terminaciones plateadas. Cierre con velcro. Fabricado en poliéster 190T.

56 x Ø95 cm



G(1), N(8), R

100% PET RECICLADO



MANGO MADERA



01 60 05 02



WIND-PROOF

KHASI_ 5610

Paraguas plegable de poliéster reciclado 190T RPET con funda a juego. Bastón, varillas y terminaciones en negro. Mango de madera natural. Cierre con velcro a juego, y apertura manual.

56 x Ø95 cm



G(1), N(8), L2



05



226



03



01



60

SHAKA_5601

Poncho impermeable. Con capucha y abertura para los brazos. Talla única adulto 127x102 cm. Fabricado en polietileno de baja densidad (LDPE). Presentación en funda individual.

 127 x 102 cm  50  200

 E(1)



PLA
ORGANIC & COMPOSTABLE

VOSTOK_5602

Poncho impermeable compostable. Con capucha y abertura para los brazos. Talla única adulto 127x102 cm. Fabricado en políácido láctico (PLA). Presentación en funda individual de PLA.

 127 x 102 cm  50  200

 E(1)

MANTA POLAR



ANTIPILLING

BERING_ 5622

Manta de forro polar con práctica funda a juego de acabado Oxford con rejilla. Tratamiento anti-pilling. 100% poliéster 200 g/m².

130 x 160 cm 1 20

G(1), H(1), N(8), O, P



TRANSPIRABLE



55

58

02

60



226

60

05

02

31

58



ANTIPILLING

LAMBERT_ 5621

Manta de forro polar con tratamiento anti-pilling. 100% poliéster 180 g/m².

120 x 150 cm 1 20

N(8), O, P

GUANTES TÁCTILES

ZELAND_ 5623

Guantes táctiles (Dedos pulgar, índice y corazón). Zona táctil en diferente color al resto del guante. Talla única adulto. Fabricado en acrílico.

21 x 11,5 cm 10 200

N(8)



05

226

58

60

02

PROLY



PLANET_ 9009

Gorro de punto con doble vuelta. Especial para bordado. 100% acrílico. Etiqueta removible.

Consultar 10 200

SUBLIMACIÓN



NANUK_ 9004

Braga para cuello multifunción de diseño tubular y corte recto. 100% poliéster tacto algodón 130 g/m².

25 x 50 cm 25 500 Consultar

CONVERTIBLE EN GORRO



NUKKA_ 2009

Braga gorro de acabado polar con ajustador elástico. Modelo a prueba de viento. 100% poliéster polar 210 g/m².

30 x 25 cm 10 100 Consultar

+ antibacterial
ISO 22196

*Material tratado con Iones de Plata que evita la ploriferación de las bacterias.

STODDART_ 9936

Braga multiusos realizada en suave poliéster con tratamiento antibacterias.

26 x 47 cm 10 300 F(1), N(8), R



NEW



EATING & DRINKWARE

140/175



Hemos seleccionado los mejores artículos de regalo para el hogar y el día a día. Tazas, fiambreras, abridores, accesorios y mucho más.

SPECIAL SUBLIMACIÓN

NEW

340ml

KAFFIR_ 4060

Taza de cristal de 340 ml. Especial para sublimación. Presentación en caja eco.

9,5 x Ø8 cm 1 36

F(1), L2, Q



CRISTAL

sublimin



280ml

DAMASCO_ 4014

Taza metálica de estilo retro especial para sublimación. Capacidad 380ml. Presentación en caja blanca.

7,9 x Ø8,8 cm 1 48

F(4), L2, Q

TAZA METÁLICA



NEW

250ml

MARANG_ 4084

Taza de cerámica de 250 ml. especial para sublimación. Presentación en caja blanca.

7,4 x Ø8,4 cm 1 48

F(4), Q

ACABADO BRILLO



0103

0131

0160

0105

01226

0102

350ml

MANGO_4001

Taza de cerámica de 350ml especial para sublimación. Interior y asa en color. Presentación en caja blanca.

9,6 x Ø8,2 cm 1 36

F(4), Q



matition



350ml

ACABADO BRILLO

LIMA_4000

Taza de cerámica de 350ml especial para sublimación. Presentación en caja blanca.

9,6 x Ø8,2 cm 1 36

F(4), Q



350ml

ACABADO MATE

RAMBU_4003

Taza de cerámica de 350ml con diseño en acabado mate. Especial para sublimación. Presentación en caja blanca.

9,6 x Ø8,2 cm 1 36

F(4), Q

TAZA METÁLICA



NEW



05



02



60



251



226

280ml

KIWAN_4083

Taza metálica de doble pared con exterior a color.
Capacidad 280 ml. Presentación en caja blanca.

8,9 x Ø7,6 cm

1

50

F(1), L1

**NEW**

02



60



226



05



03

210ml

GUAYA_ 4082

Taza metálica de doble pared con asa mosquetón.
Capacidad 210 ml. Presentación en caja blanca.

8 x 7 cm

1

50

F(1), L2



TAZA METÁLICA

Diseño retro



0101

0301

6001

0501



5601

0201

380ml

ANON_ 4015

Taza metálica de 380 ml con estilo retro.
Presentación en caja blanca.

 7,9 x Ø8,9 cm  1  48

 F(4), L2



370ml

YUCA_ 4005

Taza de cerámica de 370 mL.
Presentación en caja blanca.

9,8 x Ø8,2 cm 1 36
F(4)



03



31



60



226



02



05

370ml

PAPAYA_ 4006

Taza de cerámica en color de 370ml.
Presentación en caja blanca.

9,8 x Ø8,2 cm 1 36
F(4)

DISEÑO RETRO



300ml

JACK_ 4010

Taza de cerámica de estilo retro con asa redonda. Capacidad 300 ml. Presentación en caja blanca.

8,7 x Ø8,5 cm 1 36

F(4)



0101

0301

3101

6001

24201

11401



0103

0131

0160

0105

01226

350ml

AKEBIA_ 4008

Taza de cerámica de 350 ml. Interior y cuchara a color. Presentación en caja blanca.

10,5 x Ø8,3 cm 1 36

F(4)



TAZA MÁGICA

NEW



350ml

OKRA_ 4085

Taza mágica de cerámica en acabado mate. Capacidad 350 ml. Vierte líquido caliente en ella y descubre el diseño escondido. Presentación en caja blanca.

9,6 x Ø8,2 cm 1 36

F(1), Q



01

03

60

05

350ml

PALTA_ 4007

Taza pizarra de 350 ml. Incluye tiza. Presentación en caja blanca.

9,6 x Ø8,2 cm 1 36

F(1)



251

260

350ml

ZALA_ 4024

Taza de cerámica de 350 ml con diseño en acabado brillo. Especial para grabado láser. Presentación en caja blanca.

9,6 x Ø8,2 cm 1 36

F(4), L2

TAZAS DE CERÁMICA

BAMBÚ



BAMBOO



BERRY_ 4012

Taza de cerámica en acabado mate con tapa de bambú natural. Capacidad 370 ml. Presentación en caja de cartón Kraft.

10,5 x Ø8,2 cm 1 36

F(1),L2



ACABADO MATE

BAMBOO



CORCHO

ACABADO MATE



ROSELLA_ 4013

Taza de cerámica con diseño en acabado mate y base de corcho natural. Capacidad 420 ml. Presentación en caja de cartón kraft.

11 x Ø9 cm 1 36

F(1)

PLA
ORGANIC & COMPOSTABLE

450ml

BUSTAN_ 4062

Vaso reutilizable de PLA con tapa enroscable y capacidad 450 ml.

13,4 x Ø9,3 cm 1 50

F(1)



TAPA ROSCA

NEW

NEW



PLA
ORGANIC & COMPOSTABLE

350ml

PARCHA_ 4063

Taza reutilizable de PLA con 350 ml. de capacidad.

8,8 x Ø7,9 cm 50 100

E(4)



NEW

PLA
ORGANIC & COMPOSTABLE

1L

YOBO_ 4065

Fiambarrera realizada en PLA con cinta de ajuste. Incluye tenedor, cuchara y cuchillo. Capacidad 1 L.

19 x 11 x 8,5 cm 50 100

E(1)



PLA
ORGANIC & COMPOSTABLE

500ml

NUTRI_ 4022

Vaso de papel 500 ml. Capa interior de PLA. Biodegradable / Compostable.

13,4 x Ø8,9 cm 50 1000

C(1)

FIBRA DE BAMBÚ



MIKAN_ 4016

Taza de 350 ml en fibra bambú y PP.

8,8 x Ø7,9 cm 50 100

E(1)



TAPA ROSCA



YUZU_ 4018

Vaso con tapa a rosca de fibra de bambú y PP.
Capacidad 460 ml.

11,5 x Ø9,5 cm 1 50

E(1)

+ antibacterial

ISO 22196

*Material tratado con Iones de Plata que evita la ploriferación de las bacterias.



antibacterial
ISO 22196

GOSTO_ 4064

Vaso plegable antibacterias con tapa y mosquetón de transporte. Capacidad 220 ml.

9 x Ø6,8 cm 50 200

D(4), W



NEW





ARECA_4019

Fiambarrera con cubiertos realizada en fibra de bambú y PP. Con cinta elástica para transporte. Capacidad 650 ml.

16,6 x 5,1 x 11,2 cm 1 50

E(1)



2960 2929 29226 2905



NASHI_4017

Vaso con tapa de fibra bambú y PP. Banda de silicona. Capacidad 380 ml.

11,2 x Ø9,4 cm 10 100

E(1)



NEW



SAMBAL_ 4061

Fiambrrera de vidrio con tapa de bambú y banda de silicona. Capacidad 900 ml. Presentación en caja diseño eco.

20 x 6 x 15 cm 1 20

F(1), L2



coco_ 4081

Taza de cristal con tapa y cuchara de bambú. Capacidad 420 ml. Presentación en caja diseño eco.

9,5x Ø8 cm 1 36

F(1), C(4), L1

NEW

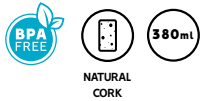

**SACHA_ 4057**

Vaso reutilizable con capacidad 380 mL. Cuerpo de PP con recubrimiento de corcho natural.

8,5 x Ø11 cm 1 40
C(1)

NEW**NEW****MALOW_ 4077**

Set de 2 pajitas de acero inox. 304 con funda de algodón. Incluye cepillo limpiador.

21,5 x Ø0,6 cm 100 400
E(1), L1, N(8)



01

02

LADAS_ 4068

Pajita extensible reutilizable de acero inox. 304 con boquilla de silicona. Incluye cepillo limpiador y estuche con mosquetón para transporte.

10,5 x Ø1,6 cm 100 500
E(1), L1

NEW

DOBLE BOLSILLO

RROLY



RROLY



01

03

31

60



05

226

02

40



DUCASSE_ 9129

Delantal largo con doble bolsillo frontal y cintas a juego. 90% poliéster 10% algodón, 150g/m² Etiqueta removible. Talla única.

65 x 90 cm

10

100

Consultar



01

60

05

02



RAMSAY_ 9128

Delantal largo con cintas de cuello y cintura a juego. 80% poliéster 20% algodón, 190g/m². Etiqueta removible. Talla única.

65 x 90 cm

50

100

Consultar



01

60

05

03



226

02

40

KELLER_ 9130

Delantal de non-woven a color con bolsillo central.
Talla única ajustable. Bolsillo 22x17cm.

50 x 73 cm

10

200

E(1)



05

02

60

ROCA_ 9132

Manopla de cocina en suave algodón / poliéster con una cara lisa para marcaje.

19 x 30,5 cm

25

200

E(1), N(8)

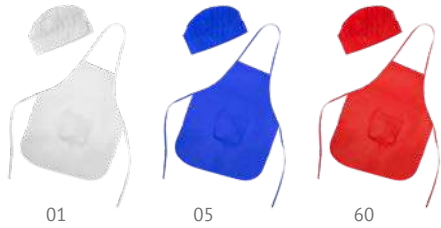

01

05

60

JAMIE_ 9133

Set infantil delantal y gorro. Realizado non-woven de 80 g/m². Talla única ajustable. Bolsillo delantal 17x17cm.

Consultar

10

300

E(1)



BOLSILLO



CERAS INCLUIDAS

PACHU_ 9131

Delantal infantil de non-woven con diseño para colorear. Incluye 5 ceras en varios colores. Talla única ajustable.

43 x 43 cm

50

200

F(1)





NEW



03 01 60 226 05

MANDY_4086

Bidón de PET flexible en forma de camiseta. Tapón de seguridad y mosquetón para transporte. Capacidad 470 ml.

17 x 3,3 x 25,5 cm 50 400

E(1)

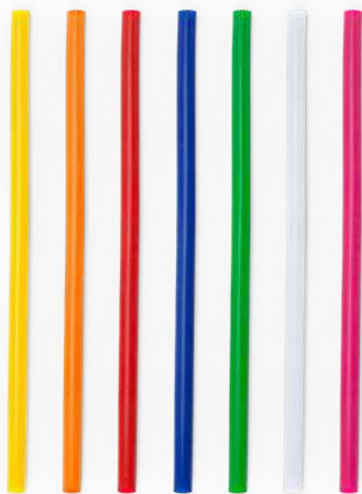

03 31 60 05 226 01 40

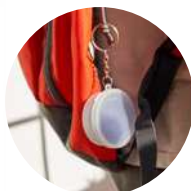

FINGER_4021

Pajita de silicona reutilizable en un práctico estuche de PP translúcido con llavero.

2 x Ø5,5 cm 100 500

B(4), W



114 03 60 05 01



PARBU_4023

Set pajita y tenedor en estuche con mosquetón para transporte. PP / Silicona.

3,7 x 9,3 x 1,7 cm 50 400

B(4)

TERMO DOBLE PARED

NEW



FENGI_4035

Termo de acero 304 doble pared y bambú. Capacidad 420 ml. Incluye cinta para transporte. Presentación en caja diseño eco.

25,5 x Ø6 cm 1 25

F(1), L2



DOUBLE WALL

BAMBOO



DOUBLE WALL

SUBLIMACIÓN



01

60

05

251

02



CELERY_4048

Termo de acero inoxidable 304 con doble pared. Acabado mate. Capacidad 500ml. Presentación en caja diseño.

24,5 x Ø6,9 cm 1 30

F(1), L2,

Q



BAMBOO

YABA_ 4033

Vaso de acero inoxidable 304 con pared exterior de bambú natural. Capacidad 500ml. Presentación en caja diseño de cartón kraft.

17,5 x Ø8,2 cm 1 50

F(1), L2



FILTRO

BAMBOO



BAMBOO

KINATA_ 4032

Bidón de acero inoxidable con doble pared. Pared exterior en bambú natural. Capacidad 500ml. Presentación en caja diseño de cartón kraft.

24,5 x Ø6,9 cm 1 30

F(1), L2



DOUBLE WALL



NEW



SILICONA



BAMBÚ



BAMBOO

NAGAMI_ 4055

Bidón de cristal con tapón de bambú y funda de silicona en color. Capacidad 500 mL. Presentación en caja diseño.

23,1 x Ø6,7 cm 1 30

F(1), L2

BAMBOO



BAMBOO

TRILBY_ 4020

Bidón de cristal de 450 ml con tapón de bambú y cinta transporte de acabado natural. Presentación en caja diseño eco.

19,7 x Ø6,4 cm 1 50

F(1), L2

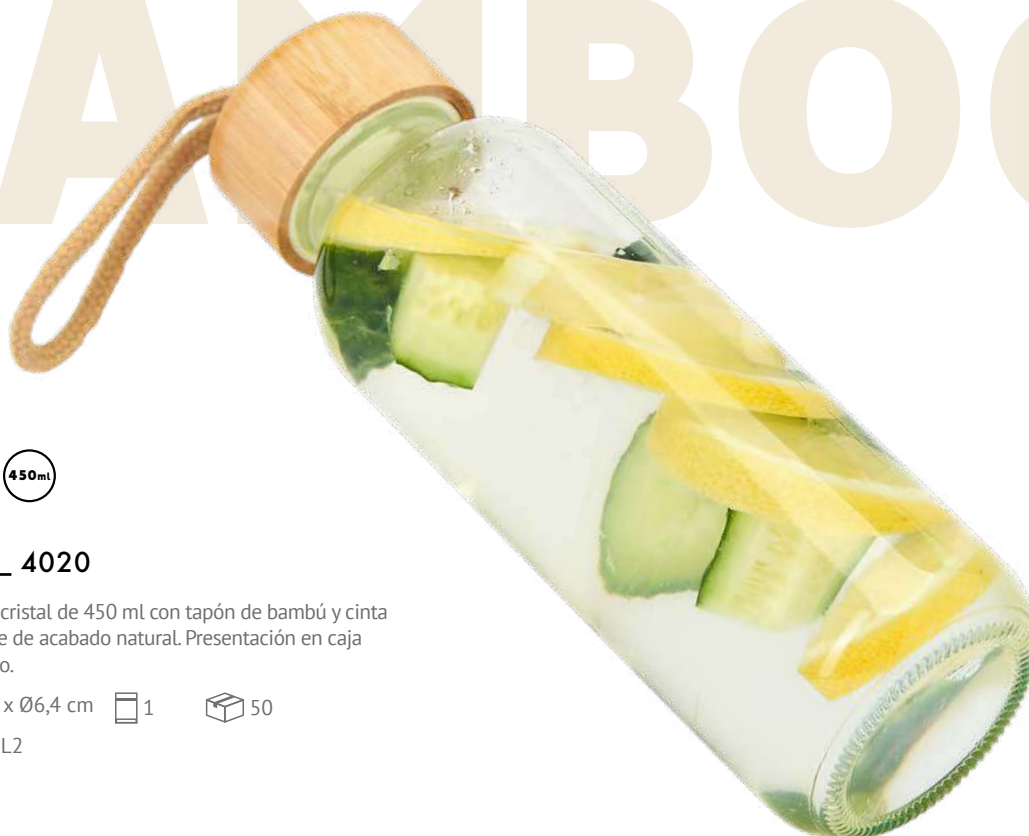

BOTELLA DE CRISTAL

NEOPRENO



01

03

31

60

05

226

02

40

500ml

CAMU_ 4040

Bidón de cristal de 500 ml. Funda y cinta de transporte a color. Presentación en caja diseño.

22 x Ø6,7 cm

1

40

F(1), N(8), L2, Q

SUBLIMACIÓN

BOTELLA DE CRISTAL

NEW



31

03

05

226

40

60

00

02

500ml

ALFE_ 4037

Bidón de cristal con cuerpo en color.
Capacidad 500 ml. Incluye cinta para
transporte. Presentación en caja diseño.

22 x Ø6,3 cm

1

50

F(1), L2

NEW

01

60

05

02

850ml

ALKE_ 4034

Bidón de acero 304 con cuerpo en 2 tonos y acabado mate. Tapón con asa flexible de goma. Capacidad 850 mL. Presentación en caja diseño.

24,7x Ø7,5 cm  1  30

 F(1), L(2)



60 226 05 02 01



01 60 05 251 02

630ml

PITA_ 4011

Bidón de acero inoxidable 304. Capacidad 630 mL.
Diseño en color sólido de acabado mate.
Presentación en caja diseño.

25,5 x Ø7,1 cm 1 30

F(1), L2

700ml

ALPINIA_ 4042

Bidón de Acero inoxidable 304. Capacidad 700 mL.
Presentación en caja diseño.

25,5 x Ø7,1 cm 1 50

F(1), L2

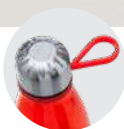

00 60 05 226



EDDO_4041

Bidón de 700 ml en acabado AS transparente. Tapón y base de acero inoxidable. Presentación en caja diseño.

26,5 x Ø7,1 cm 1 30

F(1), L2



01 03 31 60 05 226



MARACA_4043

Bidón reutilizable con colorido cuerpo de PS. Capacidad 750 ml.

25,5 x Ø7,5 cm 1 30

E(1)

SUBLIMACIÓN



BOTELLAS DE ALUMINIO

800ml

BAOBAB_ 4049

Bidón de aluminio con mosquetón. Capacidad 800ml.
Presentación en caja diseño.

24,6 x Ø7,3 cm 1 50

F(1), L2

SUBLIMACIÓN



400ml

ATHLETIC_ 4045

Bidón de aluminio con mosquetón. Capacidad 400ml.
Presentación en caja diseño.

17,5 x Ø6,6 cm 1 50

F(1), L2, Q

NO SUBLIMABLE



330ml

YACA_ 4004

Bidón de aluminio con mosquetón de color a juego. Capacidad 330ml.
Presentación en caja diseño.

15 x Ø6,6 cm 50 100

F(1), L2





NEW



01

60

226

05

02

03

251



CHITO_ 4058

Bidón de aluminio con cuerpo en acabado sólido. Capacidad 680 ml. Tapón con boquilla retráctil y asa para transporte. Presentación en caja diseño.

22,1 x Ø7,3 cm 1 50

F(1), L2

sublimation

NEW

colors



05

60

251

01

SUBLIMABLE



BOINA_ 4039

Bidón de acero inoxidable 304 y bambú. Capacidad 650 ml. Presentación en caja diseño.

20,5 x Ø7,3 cm 1 50

F(1), L2, Q



TAPA ROSCA



01 60 05 02 251



SALAK_ 4028

Vaso de acero inoxidable de 310 ml con tapa PP. Presentación en caja diseño.

16,7 x Ø7,2 cm 1 50

F(1), L2



01 31 60 05 251 02 226



MILU_ 4029

Vaso de acero inoxidable de 290 ml con tapa PP. Presentación en caja diseño.

14,4 x Ø7,3 cm 1 50

F(1), L2

TAPA ROSCA

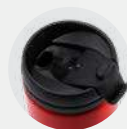

60 05 251 23



LONGAN_ 4031

Vaso de acero inoxidable de 550 ml con tapa transparente. Presentación en caja diseño.

17,1 x Ø8,8 cm 1 30

F(1), L2



01

60

226

02

05



470ml

LULO_ 4025

Taza de PP térmico con tapa. Cuerpo a color.
Capacidad 470 ml.

16 x Ø8,5 cm



25

F(1)



TAZAS METAL



02

60

05



450ml

MAMEY_ 4026

Vaso de acero inoxidable de 450 ml de capacidad.
Presentación en caja blanca.

18,8 x Ø8,7 cm



50

F(1), L2



05

02

60



450ml

DURIAN_ 4027

Taza de acero inoxidable con asa de PP. 450 ml de capacidad. Presentación en caja blanca.

17,6 x Ø8,7 cm



50

F(1), L2

BOTELLAS TRITÁN

Perfectas para cualquier situación



ALOE_ 4044

Bidón de tritán 600mL. Tapón con cinta de transporte a color. Presentación en caja diseño.

22,5 x Ø6,6 cm 1 50

F(1), W



**NEW****KINKAN_ 4038**

Bidón de tritán con cuerpo en color translúcido. Tapón a juego con asa de transporte integrada. Capacidad 650ml. Presentación en caja diseño.

25,7 x Ø6,7 cm 1 50

F(1), W



ESPECIAL DEPORTE



NEW



01 03 31 60 05 226 02



KUMAT_4036

Bidón deportivo de PE con capacidad 840 ml.

23,5 x Ø7,5 cm 10 50

F(1)



01 03 31 60 05 226 02



BIKING_ 4047

Bidón deportivo de PE con amplia superficie de marcaje.
Capacidad 620ml.

20,5 x Ø7,5 cm 10 100

F(1)



01 03 31 60 226 02 05



RUNNING_ 4046

Bidón deportivo de PE. Capacidad 520ml.

19,5 x Ø6,5 cm 10 100

F(1)





GIFT, PREMIUM & TOOLS

176/191



Regalos con estilo propio que harán que tu marca esté siempre visible. Abridores, llaveros, multiherramientas y mucho más.



BAMBOO



SHERRY_ 4088

Abridor imantado de bambú con función posavasos.

1,1 x Ø6 cm

50

500

D(4), L1

NEW



NEW



SHAKE_ 4078

Abridor de diseño realizado en madera natural con interior de acero inox. Incluye troquel superior para colgar.

17,9 x 4,1 cm

50

100

D(4), L1, W

NEW



NATURAL CORK

CHALA_ 4087

Posavasos de corcho natural.

0,3 x Ø10 cm

500

1000

D(1), L2





MERLOT_ 4075

Sacacorchos de estilo clásico en acero inoxidable con dos posiciones. Presentación en caja blanca.

12 x 2,1 x 1,3 cm 10 200

E(1), L1



SYRAH_ 4076

Sacacorchos metálico con forma de botella. Plástico PS. Presentación en caja blanca.

12 x Ø2,5 cm 50 200

D(1)



IMÁN





60 226 251 02 05

LAGER_ 4072

Abridor de aluminio de diseño clásico.

3,8 x 8,5 x 0,3 cm 100 1000

D(4), L1



226 60 05 251 02

STOUT_ 4071

Llavero abridor de aluminio con forma de botella.

3 x 8,9 x 0,2 cm 100 1000

D(4), L1



05 226 251 02 40 60

SPARKLING_ 4070

Llavero abridor de aluminio.

1,1 x 6,7 x 1,5 cm 200 1000

D(4), L1



60 05 226 251 02 31

MALT_ 4074

Llavero abridor de aluminio.

0,9 x 7,9 x 1,5 cm 200 1000

D(4), L1

NEW



DALTON_ 4089

Llavero anticontacto realizado en ABS con tratamiento antibacterias.

7 x 4 x 0,4 cm 50 1000

D(1)



ABRIDOR



ROSS_ 4052

Llavero anti-contacto multifunción de aluminio. Evite tocar cualquier superficie: pulsador, abre puertas, abridor, etc.

6,6 x 2,7 x 0,3 cm 100 1000

D(4), L1



PALE_ 4073

Llavero mosquetón de aluminio.

3 x 6 x 0,5 cm 200 1000

D(1), L1

TONIC_ 4050

Llavero moneda para carro compra. Metálico con esmalte color.

6 x Ø2,3 cm 100 1000

D(1)

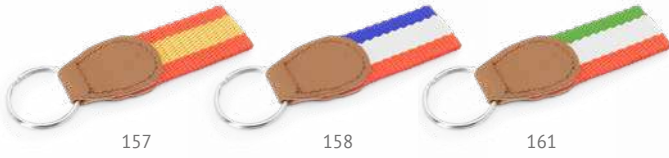

NEW



FLAG_ 4080

Llavero de poliéster con diseño de bandera y refuerzo de PU.

12 x 3 cm 50 400
E(1), L1



MINERAL_ 4051

Llavero metálico con tira de color en poliéster.

2,8 x 6,5 x 0,6 cm 50 300
D(4), L1



BUDAN_ 4054

Llavero de madera natural. Especial para grabado láser.

D(4), L1 200 800

0,5 x Ø 5 cm



982



983

6 x 0,3 x 3,5 cm



982

0,5 x Ø 5 cm



981

4 x 0,5 x 6 cm

CORCHO NATURAL



HIBIS_ 4053

Llavero de corcho natural.

D(1), L1 200 800



NEW

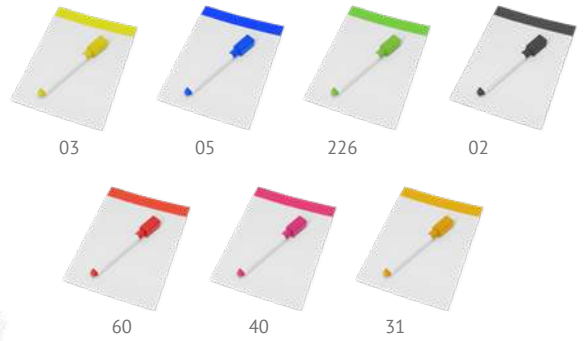

LILIAN_ 8047

Pizarra y rotulador magneticos en variados colores. Rotulador tinta negra con borrador incluido.

10,5 x 15 cm 25 200

D(4)

child's



PACHU_ 9131

Delantal infantil de non-woven con diseño para colorear. Incluye 5 ceras en varios colores. Talla única ajustable.

43 x 43 cm 50 200

F(1)



AZOR_ 7529

Bolsa infantil de non-woven con diseño para colorear. Incluye 5 ceras en colores variados.

20,5 x 22 cm 50 100

F(1)



TURCAZ_ 7530

Mochila infantil de cuerdas realizada en non-woven. Con diseño para colorear. Incluye 5 ceras en colores variados.

25 x 30 cm 50 200

F(1)

CERAS INCLUIDAS



03 01 60 226 05

SITO_ 4079

Llavero con osito de peluche realizado en suave poliéster y camiseta a color.

6,5 x 7,5 x 4 cm 25 500

E(1), N(8)

NEW



Play



NEW

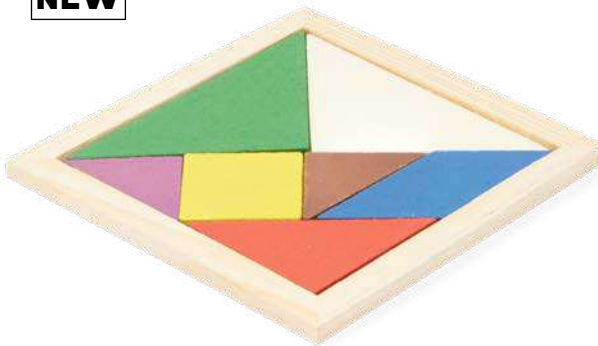

LEIS_ 0111

Puzzle Tangram de madera natural con 7 piezas a color.

10,3 x 0,7 x 10,3 cm 100 400

E(1), L2

ROSKO_ 0112

Yoyo de madera natural con cordón de 100 cm.

2,8x Ø5,5 cm 50 400

C(4), W, L1



NEW

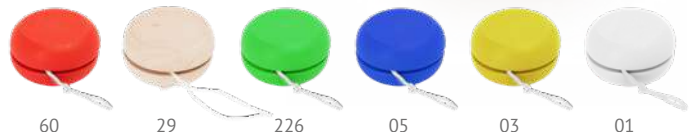

60 29 226 05 03 01

LIBÉRATE DEL ESTRÉS



PIZARRA

KING_ 1307

Vela aromática con porta velas pizarra de cerámica. Incluye tiza blanca. Presentación en caja diseño eco.

7,8 x Ø7 cm

1

50

E(1),L2

FLAKE_ 1306

Vela aromática en vivos colores presentada a juego con porta velas metálico. Tapa con ventana transparente.

3 x Ø6,3 cm

50

250

E(1), L1



01



60



40



31



05



03



02



226

**SEYKU_ 1228**

Pelota anti estrés realizada en PU de color liso.

Ø6,2 cm

20

400

E(1)

**BIKU_ 1229**

Corazón anti estrés realizado en PU de color liso.

5 x 7 x 7,1 cm

20

400

E(1)

MULTIHERRAMIENTA



01

60

02

05

251



NEW

KANCHAN_ 8024

Bolígrafo multiherramienta 4 en 1: nivel, regla en centímetros y pulgadas, destornillador con cabeza plana y estrella. Cuerpo con acabado metalizado, mecanismo giratorio y clip metálico. Tinta azul.

14,9 x Ø1 cm 50 1000

B(4)

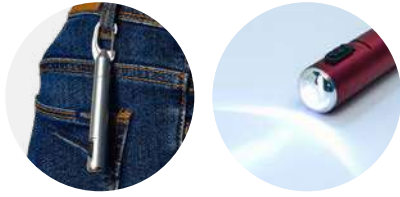
**NEW****ARAYA_ 8023**

Bolígrafo linterna de luz LED con cuerpo de ABS metalizado. Mosquetón integrado en la capucha. Tinta azul.

11 x Ø1 cm 50 500

B(4)



251

02

60

05

**SHERLOCK_ 0104**

Lupa cuentahilos plegable de 8 aumentos. Con regla de medición integrada en el cuerpo. Presentación en caja individual.

3,8 x 5,8 x 1,3 cm 50 400

C(4)

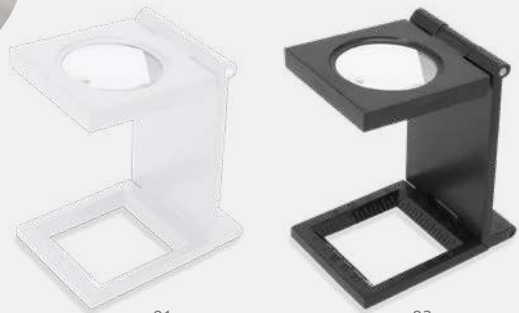
NEW

01

02

**MATA_ 8003**

Minilápiz de madera en acabado natural con goma. Cuerpo redondo.

10 x Ø0,5 cm 100 2000

A(4)

ILUMINA TU CAMINO

NEW



BRILL_ 0107

Linterna con 3 luces LED y carga manual. Disponible en varios colores translúcidos, con cinta de transporte en color gris a juego con el pulsador. Presentación en caja individual.

10,5 x 5 x 2,5 cm 25 200
E(4)



HALE_ 0109

Linterna de aluminio en acabado metalizado con 1 LED. Incluye mosquetón de transporte a juego. Pilas de botón incluidas.

6 x Ø1,5 cm 100 600
D(4), L1

NEW



LUZ 3 POSICIONES



NEW



FLASH_ 0110

Linterna deportiva con cinta para ajuste multiusos. 8 luces LED COB con 3 modos de iluminación. 3 Pilas AAA no incluidas. Presentación en caja individual.

6,1 x 4 x 1,7 cm 100 500
E(1)

NEW



LOCK_ 0108

Cutter de cuchilla ancha y cuerpo de ABS. Agarre ergonómico troquelado y capucha extraíble para el corte y ajuste de la cuchilla.

3 x 15,5 x 1,4 cm 100 500
 C(4)



NEW

5M

PICK



NEW

3M

RIVET

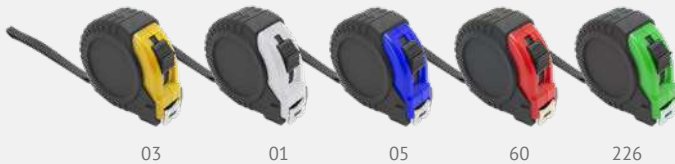

PICK_ 0106

Fléxometro de 5 metros homologado con mecanismo de bloqueo y cuchilla metálica. Cuerpo en color con funda de goma, clip metálico y cinta de transporte. Presentación en caja individual.

7 x 3,5 x 7 cm 10 50
 E(1)

RIVET_ 0105

Fléxometro de 3 metros homologado con mecanismo de bloqueo y cuchilla metálica. Cuerpo en color con funda de goma, clip metálico y cinta de transporte. Presentación en caja individual.

6,5 x 3 x 6 cm 10 50
 E(1)

PROTEGE TU COCHE DEL SOL



BORA_ 0103

Cubre volante redondo con capa frontal en aluminio metalizado. Ribete en color negro. Presentación en plano.

 Ø44 cm

 F(1)

 200



AKALA_ 0100

Parasol con frontal en aluminio de acabado metalizado, ribete de poliéster y argollas metálicas reforzadas. Incluye ventosas de sujeción y gomas elásticas para plegado. Presentación en plano.

 130 x 60 cm

 G(1)

 100

**NEW****130 X 80 CM****BATUR_0102**

Parasol tamaño maxi con burbuja a doble cara realizado en aluminio acabado metalizado y ribete en poliéster. Incluye argollas metálicas con ventosas y cintas elásticas para plegado. Presentación en plano.

130 x 80 cm

100

G(1)

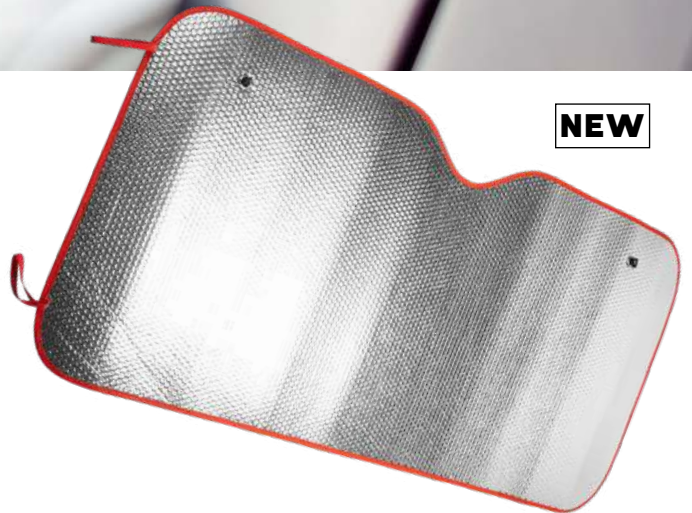
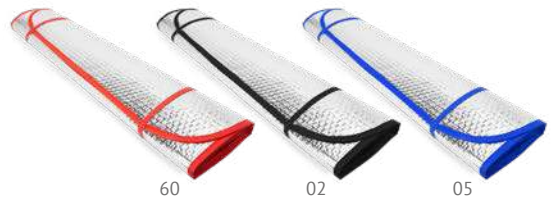
**NEW****130 X 65 CM**

60

02

05

KINI_0101

Parasol con burbuja a doble cara realizado en aluminio acabado metalizado y ribetes en color. Incluye argollas metálicas con ventosas y cintas elásticas para plegado. Presentación en plano.

130 x 65 cm

100

G(1)

SUBLI MA TION

192/197



SISON_ 7154

Mochila ligera y compacta en resistente poliéster 600D. Bolsillo frontal de apertura vertical. Con acolchado en espalda y cintas de hombros. Etiqueta removible.

23 x 40 x 12 cm 1 50

F(1), G(1), N(8), O, R



01

**MITO_ 7527**

Bolsa de la compra en non-woven cosido con asas reforzadas. Ideal para sublimación. Asas de 70cm.

36 x 40 cm 50 250

F(1), N(8), R



01

**HAMELIN_ 7114**

Mochila de cordones con ojales metálicos realizada en poliéster 210D. Etiqueta removible.

34 x 42 cm 50 300

F(1), N(8), R



01

**NINFA_ 7152**

Mochila de cordones con esquinas reforzadas realizada en poliéster 210D. Bolsillo frontal con cremallera y salida para cables. Etiqueta removible.

34,5 x 45 cm 10 200

F(1), G(1), N(8), R



01

TOCO_ 7522

Bolsa de la compra plegable en suave poliéster 190T en acabado cosido. Incluye práctico elástico para plegado.

42,5 x 38 x 7 cm 20 400

F(1), G(1), H(1), R

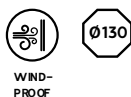

HARUL_5609

Paraguas XL de poliéster 190T con mango, bastón y terminaciones en negro. Varillas largas de fibra de vidrio con sistema antiviento. Botón de apertura automática. Mango de EVA. Cierre con velcro a juego.

83 x Ø130 cm 1 25

G(1), N(8), R

01



Ø105

MILFORD_5608

Paraguas con tela y mango a juego. Varillas y terminaciones en negro. Cierre con velcro y apertura automática. Fabricado en poliéster 190T.

83 x Ø107 cm 1 25

G(1), N(8), R



01



01

Ø95

YAKU_5606

Paraguas plegable de apertura manual con funda a juego. Mango, varillas y contera plateados. Cierre con velcro. Fabricado en poliéster 190T.

56 x Ø95 cm 1 60

G(1), N(8), R





01

NANUK_ 9004

Braga para cuello multifunción de diseño tubular y corte recto. 100% poliéster tacto algodón 130g/m².

25 x 50 cm

25

500

Consultar



01

CLOUD_ 8110

Funda para gafas con cordones autocierre. Poliéster de tacto suave.

9 x 18 cm

50

1000

D(1), N(8), R

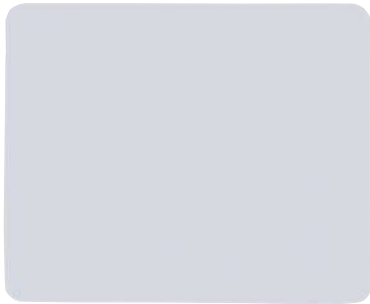

01

SIRA_ 3011

Alfombrilla para ratón de diseño plano. Superficie de suave poliéster y base antideslizante de silicona.

22 x 18 x 0,2 cm

100

200

E(1), R



01

FESTERO_ 9003

Pañoleta de diseño triangular en suave poliéster 60g/m². Color blanco ideal para marcaje en sublimación. Talla única.

100 x 70 x 70 cm

100

1000

E(1), N(8), R



01

FETE_ 3102

Pulsera ajustable de poliéster.

34,5 x 1,2 cm

500

2000

D(1), R



01

HOST_ 7053

Lanyard de poliéster con mosquetón.

2 x 50 cm

100

800

F(1), N(8), R

sublimation

sublimation



TAZA METÁLICA

DAMASCO_ 4014

Taza metálica de estilo retro especial para sublimación. Capacidad 380 ml. Presentación en caja blanca.

7,9 x Ø8,8 cm 1 48
F(4), L2, Q



TAZA CRISTAL

NEW

KAFFIR_ 4060

Taza de cristal de 340 ml. Especial para sublimación. Presentación en caja eco.

9,5 x Ø8 cm 1 36
F(1), L2, Q



ACABADO BRILLO

LIMA_ 4000

Taza de cerámica de 350 ml especial para sublimación. Presentación en caja blanca.

9,6 x Ø8,2 cm 1 36
F(4), Q



ACABADO MATE

RAMBU_ 4003

Taza de cerámica de 350 ml con diseño en acabado mate. Especial para sublimación. Presentación en caja blanca.

9,6 x Ø8,2 cm 1 36
F(4), Q



MANGO_ 4001

Taza de cerámica de 350 ml especial para sublimación. Interior y asa en color. Presentación en caja blanca.

9,6 x Ø8,2 cm 1 36
F(4), Q



0103 0131 0160 0105 01226 0102

**ATHLETIC_ 4045**

Bidón de aluminio con mosquetón. Capacidad 400ml. Presentación en caja diseño.

17,5 x Ø6,6 cm 1 50
F(1), L2, Q

BAOBAB_ 4049

Bidón de aluminio con mosquetón. Capacidad 800ml. Presentación en caja diseño.

24,6 x Ø7,3 cm 1 50
F(1), L2, Q

CELERY_ 4048

Termo de acero inoxidable 304 con doble pared. Acabado mate. Capacidad 500ml. Presentación en caja diseño.

24,5 x Ø6,9 cm 1 30
F(1), L2, Q

BOINA_ 4039

Bidón de acero inoxidable 304 y bambú. Capacidad 650ml. Presentación en caja diseño.

20,5 x Ø7,3 cm 1 50
F(1), L2, Q

CAMU_ 4040

Bidón de cristal de 500ml. Funda y cinta de transporte a color. Presentación en caja diseño.

22 x Ø6,7 cm 1 40
F(1), N(8), L2, Q



PARTY & EVENTS

198/207



Promocionales por excelencia e indispensables en cualquier evento.

CIERRE DE SEGURIDAD



05

SUBLIMACIÓN



01

03

31

60

226

02

40

GUEST_ 7054

Lanyard de poliéster con mosquetón, hebilla y cierre de seguridad.

2 x 55 cm

100

600

F(1), N(8), R



02



00

01

03

31

60

05

226

BASH_ 7070

Identificador transparente. PVC.

11 x 9,5 cm

100

1000

C(1)



29



60

55

05

02

LIBE_ 7516

Portadocumentos de poliéster 600D con un compartimento principal y cierre de cremallera. Ribetes con refuerzo y asa de transporte integrada en el diseño.

38 x 32 cm

20

100

F(1), N(8)

SUBLIMACIÓN



226

HOST_7053

Lanyard de poliéster con mosquetón.

2 x 50 cm

100

800

F(1), N(8), R

100%
Recycled
PET

SUBLIMACIÓN



03



ECOHOST_7055

Lanyard de RPET con mosquetón.

2 x 50 cm

100

800

F(1), N(8), R

100% ALGODÓN



ROOMER_7052

Lanyard de algodón con mosquetón.

2 x 50 cm

100

800

F(1), N(8)

PARA TODOS LOS EVENTOS



40

SUBLIMACIÓN



01 03 31 60 05 226 02

FETE_ 3102

Pulsera ajustable de poliéster.

34,5 x 1,2 cm 500 2000

D(1), R



01 03 221 31 60 05 242 226 02 258 40

PARTY_ 3100

Pulsera para eventos de fibra sintética con numeración individual. Presentada en placha de 10 unidades.

25,8 x 2,7 cm 1000 20000

A(1)



RROLY®



69 24 02 48



55 63 05 10

SUBLIMACIÓN



01 03 31 60 57

JARANERO_ 9006

Pañuelo de diseño triangular realizado en suave poliéster con tácto algodón 65g/m². Talla única.

100 x 70 x 70 cm 100 1000

E(1), N(8), R



69 24 02 48



55 63 05 10

SUBLIMACIÓN



01 03 31 60 57

FESTERO_ 9003

Pañoleta de diseño triangular en suave poliéster 60 g/m². Color blanco ideal para marcaje en sublimación. Talla única.

100 x 70 x 70 cm 100 1000

E(1), N(8), R



ALBERO_ 3110

Abanico con varillas de plástico y tela en poliéster.
Presentación en caja blanca.

43 x 23 cm 25 250
D(1), E(2)



CALESA_ 3111

Abanico con varillas de madera y tela en poliéster.
Presentación en caja blanca.

42,5 x 23 cm 25 250
D(1), E(2), L1



UN TOQUE DE COLOR



DUSK_7060

Sombrero de poliéster.



E(1)



25



200



29

13

GALAXY_7063

Sombrero de paja natural con banda confort interior.



Consultar



250

HALLEY_ 7062

Sombrero de paja natural con banda confort interior.

 Consultar 250**SUN_ 7061**

Sombrero de paja natural con banda confort interior.

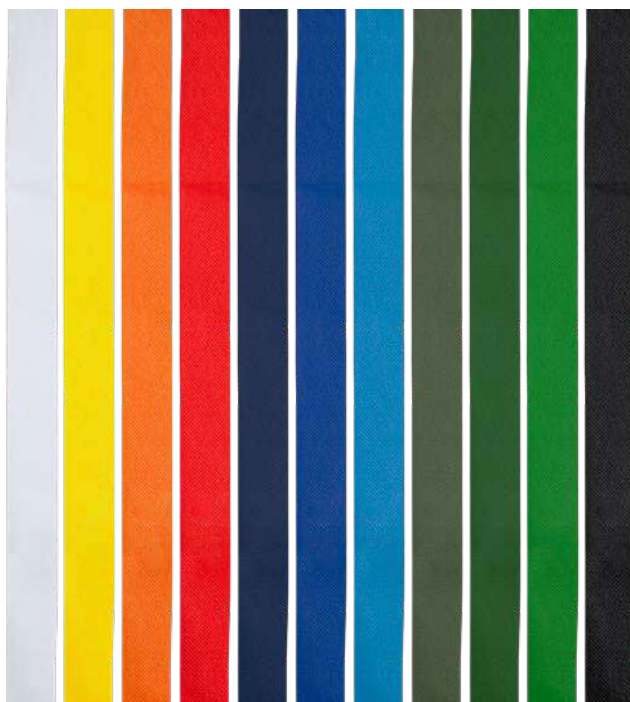
 Consultar 250

01 03 31 60 55 05 242 13 56 226 02

**CINTAS
DE MARCAJE**

Cintas de Non Woven para darle un toque de color a tus sombreros

COMET_ 7013

Cinta para sombrero de non-woven.

 67 x 2,7 cm 5000 Consultar

ANIMACIÓN

NEW



CARNIVAL_ 3101

Silbato de diseño clásico con cinta para el cuello.

1,9 x 2,4 x 5 cm 250 1000

C(1)



REVEL_ 3105

Aplaudidor con diseño bicolor en forma de mano.

18,5 x 8,5 cm 100 200

E(4)

NEW



157

NEW

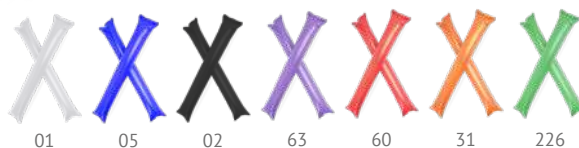

JAMBOREE_ 3106

Set de bastoms / aplaudidores inflables y reutilizables realizados en LDPE. Incluye válvula de inflado.

61 x Ø10 cm 25 500

G(1)



NEW

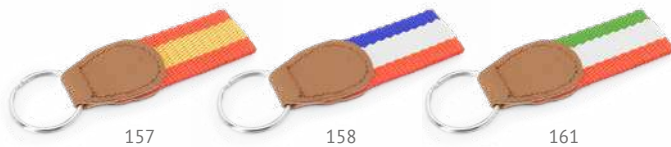

FLAG_ 4080

Llavero de poliéster con diseño de bandera y refuerzo de PU.

🗝️ 12 x 3 cm 📄 50 📦 400
 🗑️ E(1), L1

SUBLIMACIÓN :

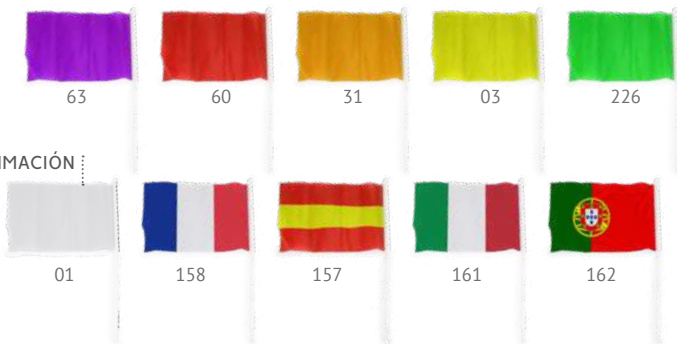

CELEB_ 3103

Banderín de animación realizado en poliéster 170T. Disponible en colores lisos y banderas.

🗝️ 21 x 14 cm 📄 10 📦 2000
 🗑️ D(6)

NEW



05



SUMMER, LEISURE & SPORTS

208/225



Disfruta de tu tiempo libre con esta selección de artículos para el verano y actividades deportivas. Gafas de sol, artículos de playa, deporte...

GAFAS DE SOL

Para que nada te deslumbre

NEW



02



01



BAMBOO

EDEN_ 8104

Gafas de sol de atractivo diseño con montura en acabado brillante y patillas en bambú natural. Lentes con protección UV400.

 14,5 x 5 x 3,2 cm  10  300

 D(4), L1



DAX_ 8102

Gafas de sol clásicas en acabado efecto madera con protección UV400.

14,5 x 4,9 x 3,2 cm 10 300

E(1)



SUBLIMACIÓN



CLOUD_ 8110

Funda para gafas con cordones autocierre. Poliéster de tacto suave.

9 x 18 cm 50 1000

D(1), N(8), R



31



03



251



05

CIRO_ 8101

Gafas de sol clásicas en acabado negro mate y lentes de espejo. Protección UV400.

 14,5 x 4,9 x 3,2 cm  10  300

 D(4)

NEW



ARIEL_ 8103

Gafas de sol con montura en acabado mate y lentes con protección UV400.

14,5 x 5 x 3,2 cm 10 300

D(4)



BRISA_ 8100

Gafas de sol clásicas en acabado brillo con protección UV400.

14,5 x 4,9 x 3,2 cm 10 300

D(4)



100% PET RECICLADO

Fabricada a partir de PET reciclado

PROLY



01

03

60



55

05

226

02

CALISTO_7050

Gorra de RPET con 5 paneles.
Cierre de velcro ajustable.

E(1), N(8), O, P 25 300



01

03

60



05

55

226

02



BASICA_7000

Gorra de 5 paneles en material 80% poliéster 20% algodón. Con orificios de ventilación bordados y cierre de velcro ajustable. Etiqueta removible.

Consultar 25 300

PROLY



ERIS_7019

Gorra de 5 paneles con sándwich a contraste y cuatro orificios de ventilación cosidos. Cierre de velcro ajustable y etiqueta removible. 100% Algodón 170g/m².

Consultar 25 200



URANUS_7041

Gorra de 5 paneles en material 100% algodón 170g/m². Cierre ajustable de velcro y orificios de ventilación cosidos. Etiqueta removible.

Consultar 25 300



PANEL_7008

Gorra de 6 paneles en material 100% algodón con sándwich a contraste. 6 orificios de ventilación y cierre de velcro ajustable. Etiqueta removible.

Consultar

25

200



MERCURY_7020

Gorra técnica de 3 paneles. Tejido ligero y transpirable con cierre de velcro ajustable. 90% poliéster 10% elastano 140g/m². Etiqueta removible.

Consultar

25

200



TERRA_7012

Gorra de estilo casual de 6 paneles. Interior de la visera en acabado contraste. Ojales metálicos y cierre ajustable metálico. 100% algodón 260g/m². Etiqueta removible.

Consultar

25

200





NEW

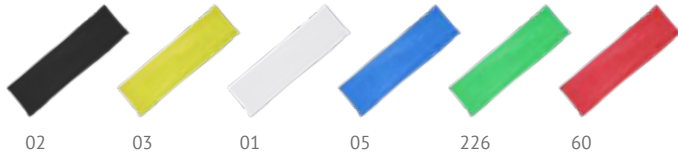

OLYMPIA_7104

Cinta elástica deportiva para la cabeza realizada en suave microfibra.

23,5 x 6 cm 100 800
 G(1), N(8), R



NEW



SPEED_7105

Muñequera elástica realizada en suave microfibra. Incorpora bolsillo con cierre de cremallera.

10 x 9 cm 100 1000
 E(1), N(8), R

PROLY

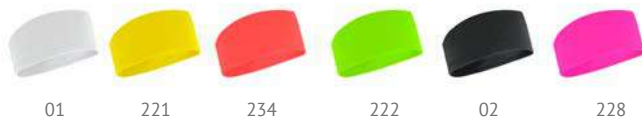

CROSSFITTER_9001

Cinta técnica deportiva en tejido técnico transpirable. 100% poliéster 140g/m².

22,5 x 8 cm 10 300
 Consultar



MARATHON_7118

Cinturón deportivo multiusos de tejido elástico impermeable. Cremallera reflectante y salida para cables. 100% poliéster. Etiqueta removible.

23 x 5,5 cm 10 200
 Consultar

ESTERILLA DE YOGA

Con bolsa para transportar



BOLSA
TRANSPORTE



CHAKRA_ 7102

Esterilla de yoga con práctica funda de transporte.
Ligera, resistente y adherente al suelo.

 180 x 60 cm  1  20

 G(1)



3 Niveles



EMON_ 7097

Set bandas elásticas para fitness con diferentes resistencias. Funda de poliéster. Bandas de latex.

9 x 21 cm 20 100

E(1)



60



CALPE_ 7101

Toalla refrescante de microfibra. Presentada en un práctico estuche con mosquetón.

13 x 5,4 x 3 cm 50 200

G(1), N(8)

+ antibacterial

ISO 22196

*Material tratado con Iones de Plata que evita la ploriferación de las bacterias.



SANCAR_ 9938

Toalla absorbente de suave microfibra 350 g/m² con tratamiento antibacterias. Presentada en funda de PVC.

45 x 30 cm   100
 G(1), N(8)

FUNDA TRASPARENTE

NEW



BAY_ 7103

Toalla absorbente realizada en microfibra 350 g/m². Incluye funda reutilizable de PVC.

45 x 30 cm   100
 F(1), N(8), O, P, R









ORLY

2 TAMAÑOS



ORLY_ 7100

Toalla de playa en diseño bicolor con práctico elástico para fácil plegado. 80% poliéster 20% poliamida 280g/m².

S  38 x 68 cm  10  100
M  60 x 145 cm  10  50
 Consultar



ORLY

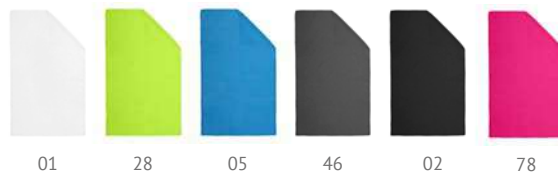

CORK_ 7119

Toalla multideporte de microfibra con práctico elástico para fácil plegado. Secado rápido. 90% poliéster 10% poliamida 190g/m². Etiqueta removible.

70 x 120 cm  10  100
 Consultar

BOLSA ESTANCA

Elige la que más se adapte a tu actividad



ALETA_7531

Bolsa impermeable de resistente ripstop. Práctica ventana táctil con bolsillo para el móvil. Sistema de cierre estanco con clic y mosquetón para transporte. Capacidad útil 2,5L. Capacidad total 3L.

29,5 x Ø11,5 cm  10  200

 F(1)



MONJE_7532

Bolsa impermeable de resistente ripstop. Sistema de cierre estanco con clic y mosquetón para transporte. Capacidad útil 5L. Capacidad total 8,5L.

35 x Ø18 cm  10  100

 F(1)



MANATI_7533

Bolsa impermeable de resistente ripstop. Sistema de cierre estanco con clic. Mosquetón y cinta bandolera ajustable para transporte. Capacidad útil 10L. Capacidad total 15L.

45,5 x Ø20,5 cm  10  100

 F(1)

NEVERAS DE PAPEL



NEW

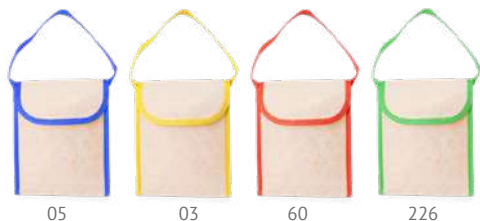

05

03

60

226



SERRETA_ 7606

Bolsa nevera de papel laminado, con interior isotérmico de aluminio. Solapa con cierre de velcro y práctica asa para transporte a color.

20 x 25 x 10 cm 50 100

F(1)



NEW



MILANA_ 7607

Nevera de papel laminado de diseño clásico, interior isotérmico de aluminio y solapa con cierre de cremallera. Incluye práctica asa para transporte.

19 x 13,5 x 14 cm 50

F(1)



TIBU_ 7603

Nevera con interior isotérmico de aluminio para 6 latas. Exterior en resistente PVC. Asa de transporte a juego y cierre de cremallera.

21 x 15 x 15 cm 25 200
 F(1), N(8)

GRULLA_ 7605

Nevera multiusos de poliéster 600D. Compartimentos interiores isotérmicos y prácticos bolsillos exteriores. Cinta bandolera ajustable acolchada con mosquetón.

25 x 24 x 15 cm 1 20
 G(1), N(8)



GRAJA_ 7604

Mochila nevera de cuerdas con interior isotérmico de aluminio. Exterior de poliéster 210D.

32 x 42 cm 10 200
 F(1), N(8)



NEW

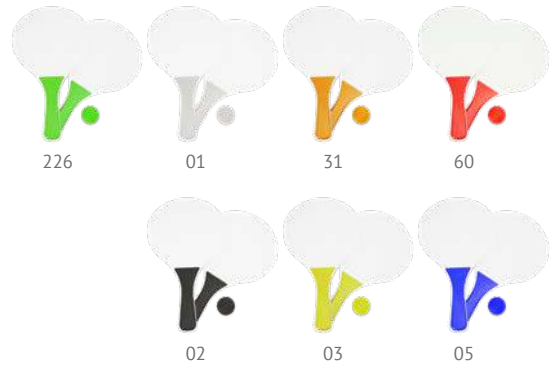

FEROE_ 1003

Palas de playa realizadas en madera con mango reforzado a color. Incluye pelota a juego. Presentadas en bolsa tipo red.

19 x 33 x 0,6 cm 1 30

F(1)



SAONA_ 2150

Balón inflable de PVC. Desinflado: 37cm. Inflado: 28cm

E(1), F(1) 100 200



KALAY_ 8150

Chanclas de playa con suela de confortable PE y tiras en PVC translúcido. Tallas 36-38, 42-44.

26 x 1,3 x 9,5 cm 10 60

D(1), E(1)

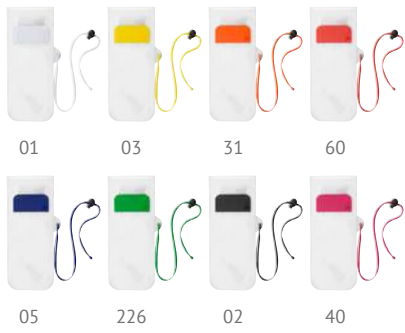

EIDER_ 8202

Portatodo impermeable de PVC apto para pantallas táctiles.

📏 9,5 x 23 cm 📦 50 📦 500

👤 E(1)



NEW



SKYE_ 1006

Sombrilla de playa de 8 paneles realizada en nylon. Protección UV interior y faldones ribeteados. Incluye funda de transporte con cinta para el hombro.

📏 Ø155 x 100 cm 📦 1 📦 12

👤 H(1), N(8)

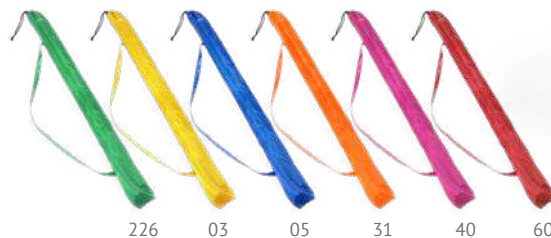

226 03 05 31 40 60



The *greenery.*
—
PURE NATURE

PERSONAL CARE

226/235



Artículos para el descanso y cuidado personal.
Neceseres, artículos de baño y hotel, espejos, etc.

BÁLSAMO LABIAL



NEW



01 03 05 226 31 40 60

LISSEN_ 1124

Bálsamo labial con clásico estuche en forma de barra en acabado translúcido. Protección SPF15.

7 x Ø1,9 cm 25 500

C(1)



251

49

260

BEISO_ 1225

Bálsamo labial presentado en estuche de diseño tipo esférica con acabado cromado. Protección SPF15.

Ø3,8 cm 50 500

C(1)

NEW



NEW



LAPP_ 1230

Bálsamo labial con clásico estuche en forma de barra realizado en fibra de trigo. Protección SPF15.

7 x Ø1,9 cm 25 500

C(1)



03

226

60

31

01

242

POLE_ 9924

Cepillo de dientes plegable en PP ideal para viajar. Cerdas de dureza suave a juego.

17,5 x 2,3 x 1,5 cm 50 500
C(1),W

FRESH_ 9923

BAMBOO



ECO

Cepillo dental con cuerpo realizado en bambú, con cerdas blancas de dureza suave. Presentación en caja diseño eco.

17,5 x 1,6 x 1,3 cm 50 400
C(4),L1



BAMBOO



05

01

60

02

GLAZE_ 1220

Práctico espejo plegable de bolsillo con carcasa de PP traslúcido.

0,5 x Ø6 cm 50 500

C(4), W



60

05

01

BLUNT_ 1221

Práctico cepillo plegable con espejo en formato bolsillo. Realizado en PP de diseño sólido.

2,3 x Ø6,6 cm 50 200

C(4)

LINER_ 1223

Espejo doble, normal y de aumento. Tapas de suave PU y cierre magnético.

0,9 x Ø7 cm 50 300

C(4), L1, W





NEW

+ antibacterial

ISO 22196

*Material tratado con Iones de Plata que evita la ploriferación de las bacterias.

DROP_ 1222

Pastillero de 3 compartimentos realizado en PP con tratamiento antibacterias.

6 x 1,3 x 3,9 cm 100 1000

C(4), W



CITOS_ 1226

Pastillero de PP con tres compartimentos. Diseño en acabado traslúcido.

6 x 1,3 x 3,9 cm 100 1000

C(4), W



MEDY_ 1227

Práctico pastillero de PP con 2 compartimentos y accesorio cortador.

9,5 x 4,8 x 1,6 cm 100 400

C(4)



SEYKU_ 1228

Pelota anti estrés realizada en PU de color liso.

Ø6,2 cm 20 400

E(1)

BIKU_ 1229

Corazón anti estrés realizado en PU de color liso.

5 x 7 x 7,1 cm 20 400

E(1)





BRANTA_ 8200

Máscara de viaje realizada en suave microfibra. Doble elástico de ajuste.

18,5 x 9 cm 100 1000

D(1), N(8)



258

55

ANSAR_ 8201

Almohadilla inflable ideal para viajar con suave tacto antelina.

33 x 9 x 25 cm 20 200

F(1)



02

NEW



01



02

YLLIER_ 8151

Zapatillas unisex realizadas en cómodo algodón/poliéster con interior acolchado. Incluye práctica funda de non woven. Talla única 36-43.

11,5 x 29 x 1,7 cm 10 200

E(1), N(8)





**100%
ALGODÓN**



2902

2960

2929

2905

29226



DOEL_ 7537

Neceser multiusos de algodón 280 g/m² con acabado bicolor. Cremallera con tirador de algodón a juego.

22,5 x 17 x 5,5 cm 50 300

E(1), N(8)



YUTE NATURAL



SIERRA_ 7558

Neceser multiusos realizado en algodón 180 g/m² y Yute. Cremallera con tirador de Yute a juego.

21,5 x 16 x 5 cm 10 200

E(1), N(8)

NECESER 100% RPET

NEW



01



02



05



226



60



BUBO_7547

Neceser de dos compartimentos con cremalleras y cinta de transporte a juego. Realizado en poliéster reciclado RPET 210D.

21 x 13 x 8 cm

20

100

F(1), N(8), O



31 60 55
05 56 02

PARDELA_ 7513

Neceser de poliéster 600D con cremallera y práctica asa de transporte.

20 x 9,8 x 8,3 cm 10 200

E(1), N(8), O



29



05



29 31 60 02 40

YUBARTA_ 7514

Neceser de poliéster 600D. Cremallera con tirador a juego.

22 x 14 x 6 cm 10 300

E(1), N(8), O



05 226 258 02

GRUS_ 7512

Neceser de poliéster 300D a color en acabado vigoré y PVC transparente. Con cremallera y práctica asa de transporte.

23,5 x 18,5 cm 100 200

E(1)



60



03



01 31 60 05 226 40

CARIBU_ 7511

Neceser con cierre hermético de PVC translucido.

17 x 13 x 5 cm 50 400

E(1)



SANITARY & PROTECTION

236/247



Amplia selección de artículos para tu protección higiénica. Mascarillas, geles hidroalcohólicos, artículos con tecnología antibacteriana, etc.



anti**bacterial**
ISO 22196



+ antibacterial

ISO 22196

*Material tratado con Iones de Plata que evita la ploriferación de las bacterias.



05 02 60

NEW

colors

01



antibacterial
ISO 22196



TOUCH
PEN

FARBER_ 8022

Bolígrafo higienizante antibacterias multifunción, con pulverizador recargable y puntero táctil. Capacidad 3 ml (líquido no incluido). Tinta azul.

16 x Ø1,5 cm 50 1000

B(4)



antibacterial
ISO 22196

ELION_ 8061

Bloc de notas A6. Cubiertas de PU con tecnología antibacteriana. Marcapáginas y banda elástica. 80 hojas. Norma ISO 22196.

14 x 9 x 1,4 cm 50 100

E(4)



antibacterial
ISO 22196

WATSON_ 8060

Bloc de notas A5. Cubiertas de PU con tecnología antibacteriana. Marcapáginas y banda elástica. 100 hojas. Norma ISO 22196.

21 x 14,9 x 1,4 cm 25 50

E(4)

+ antibacterial

ISO 22196

*Material tratado con Iones de Plata que evita la ploriferación de las bacterias.



antibacterial
ISO 22196

STARK_ 8040

Bolígrafo con cuerpo de ABS antibacterias. Tinta azul. Norma ISO 22196.

13,8 x Ø1 cm 50 1000



antibacterial
ISO 22196



TOUCH
PEN

HALLERBOS_ 8015

Bolígrafo con cuerpo de ABS antibacterias y puntero táctil. Clip metálico y carga jumbo de tinta azul. Norma ISO 22196.

13,9 x Ø1 cm 50 1000



antibacterial
ISO 22196

NEWTON_ 8038

Bolígrafo con cuerpo de ABS antibacterias. Tinta azul. Norma ISO 22196:2011.

14 x Ø1,3 cm 50 1000



03 31 60 05 226 02



antibacterial
ISO 22196

CARREL_ 8039

Bolígrafo con cuerpo de ABS antibacterias y suave agarre de color translucido. Tinta azul. Norma ISO 22196:2011.

14 x Ø1,3 cm 50 1000



antibacterial
ISO 22196

GRYFIN_ 8046

Lápiz de madera con tratamiento antibacterias y goma disponible en varios colores.

18,6 x Ø0,7 cm 100 2000



NEW



01 60 40 31 226 05 03

+ antibacterial

ISO 22196

*Material tratado con Iones de Plata que evita la ploriferación de las bacterias.

NEW



antibacterial
ISO 22196

SANCAR_ 9938

Toalla absorbente de suave microfibra con tratamiento antibacterias. Presentada en funda de PVC.

45 x 30 cm

1

100

G(1), N(8)



antibacterial
ISO 22196

STODDART_ 9936

Braga multiusos realizada en suave poliéster con tratamiento antibacterias.

48 x 26 cm

10

300

F(1), N(8), R

NEW



60

05

01

226

02

HAWKING_ 8203

Práctica funda portamascarillas.
Realizada en flexifle PP troquelado para su fácil plegado. No incluye mascarilla.

9,2 x 5,7 x 0,9 cm

100

2000

B(1)



+ antibacterial

ISO 22196

*Material tratado con Iones de Plata que evita la ploriferación de las bacterias.

NEW
colors

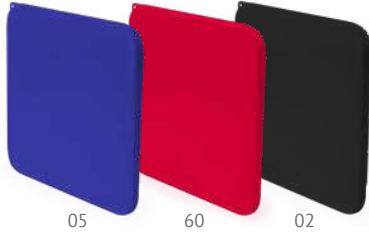

05 60 02



01



antibacterial
ISO 22196

AXEL_ 9929

Estuche portamascarillas realizado en PP antibacterias. Ideal para proteger y transportar todo tipo de mascarillas.

13 x 13 x 1,2 cm



D(1), W



antibacterial
ISO 22196



WHEAT
FIBER



NEW



WERNER_ 9932

Estuche portamascarillas realizado en PP antibacterias con doble cierre. Su diseño permite la protección y transporte de todo tipo de mascarillas, además de accesorios higiénicos.

19 x 10,5 x 1,2 cm



D(1), W



antibacterial
ISO 22196

HENRICK_ 9940

Estuche portamascarillas realizado en fibra de trigo con tratamiento antibacterias. Ideal para proteger y transportar todo tipo de mascarillas.

13 x 13 x 1,2 cm



D(1)





NEW



STRICKLAND_ 9939

Funda neceser de PVC multiusos. Cuerpo transparente con cierre a color. Ideal para guardar toda clase de mascarillas.

20 x 12,5 x 0,25 cm 20 1000
 E(1)



03



CARIBU_ 7511

Neceser con cierre hermético de PVC translúcido.

17 x 13 x 5 cm 50 400
 E(1)

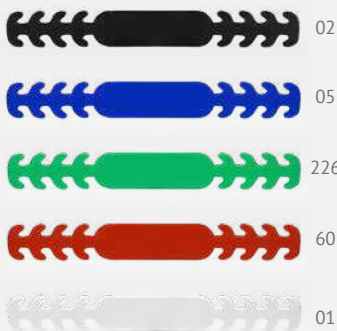

EDISON_ 9920

Sujeta mascarillas de PP en color liso, con cuatro posiciones de ajuste para un perfecto y cómodo uso.

16,5 x 2 x 0,1 cm 100 2000
 A(4)



NEW



HOLDE_ 7051

Lanyard portamascarillas de cordón y accesorio para ajuste craneal. Válido para todo tipo de mascarillas.

52 x 2 cm 10 1000
 D(1)



NEW



LASSE_ 7056

Lanyard portamascarillas realizado en suave poliéster y cómodos corchetes. Válido para todo tipo de mascarillas.

94 x 1,5 cm 10 2000
 F(1), N(8), R

2 TAMAÑOS



Kids

KEPLER_9916

Pantalla facial realizada en cartón laminado blanco y PET. Cierre ajustable con velcro. Acolchado de goma espuma para un cómodo ajuste a la frente. Catálogada como EPI.

Consultar

D(2)



FRANKLIN_9921

Gafas transparentes antivaho. Patillas con ventilación lateral. Realizadas en ligero policarbonato.

15,5 x 5,7 x 15 cm

10

200

D(4)

COHN_9905

Pantalla facial realizada en resistente material PET. Incluye cinta elástica con cómodo y ergonómico acolchado para su ajuste a la frente. Diseño anti-vaho contra salpicaduras y polvo.

33 x 22 cm

50

200

E(1)



ACOLCHADO INTERIOR



251

05

60

02

ABRIDOR



ROSS_4052

Llavero anticontacto multifunción de aluminio. Evite tocar cualquier superficie: pulsador, abre puertas, abridor, etc.

6,6 x 2,7 x 0,3 cm

100

1000

D(4), L1



01

60

05

02

NEW



antibacterial

ISO 22196

DALTON_4089

Llavero anticontacto realizado en ABS con tratamiento antibacterias.

4 x 7 x 0,4 cm

50

1000

D(1)



GEL HIDROALCOHÓLICO



**ETIQUETA
PERSONALIZABLE 100%**

MADE TO ORDER

5 L

100ml

500ml



AVOGADRO_ 9904

Gel higienizante de manos. Formula especialmente diseñada para desinfección y cuidado de la piel.

 Consultar

 Consultar

Consultar Precio

5 ACCESORIOS



ARNOLD_ 9935

Neceser de viaje transparente realizado en PVC con cierre hermético. Incluye surtido de prácticos botes ideales para gel, champú y perfume.

 19 x 19 cm

 1

 100

 E(1)

NEW



NOBEL_ 9919

Toallita higienizante hidroalcohólica de un solo uso y compostable. 70% de alcohol. Embolsado individual termosellado.

6,7 x 8 cm 100 3000
A(1)



70%

VARMUS_ 9908

NEW

Gel higienizante de manos con 70% de alcohol. Práctico recipiente de 10ml traslúcido y pulverizador tipo spray. Capucha con clip disponible en varios colores.

12,6 x Ø1,6 cm 50 500
B(4)



10ml

70%



02 01 60 226 05



BISHOP_ 9906

NEW

Gel higienizante de manos con 70% de alcohol. Práctico recipiente de 30ml con mosquetón.

3,5 x 10 x 2,2 cm 50 300
C(1)



30ml

70%



GENZEL_ 9934

NEW

Gel higienizante de manos con 70% de alcohol. 30ml con pulverizador tipo spray.

10,1 x Ø2,7 cm 100 200
C(1), W



30ml

70%



GILMAN_ 9907

NEW

Gel higienizante de manos. Práctica botella de 50 ml. 70% Alcohol.

4,5 x 8,5 x 2,9 cm 50 200
C(1)



50ml

70%

CRICK_ 9933 **NEW**

Mascarilla de seguridad de cinco capas. Acabados termosellados, con elásticos de sujeción y clip nasal.

 16 x 21 x 6 cm  1/25  1200

Consultar Precio



CURIE_ 9925

Mascarilla FFP2 NR de seguridad con acabados termosellados, elásticos de sujeción y clip nasal ajustable. Incluye accesorio para sujeción craneal. Embolsado individual sellado.

 16 x 21,6 cm  1/25  800

Consultar Precio



FLEMING_ 9930

Mascarilla médica desechable (Quirúrgica TIPO II-R). Triple capa con acabados termosellados, elásticos de sujeción y clip nasal ajustable.

 17,5 x 9,5 cm  5/50  2000

Consultar Precio



MAYER_ 9915

Mascarilla médica desechable infantil (Quirúrgica TIPO II-R). Triple capa con acabados termosellados, elásticos de sujeción y clip nasal ajustable.

 14 x 9,5 cm  5/50  2000

Consultar Precio

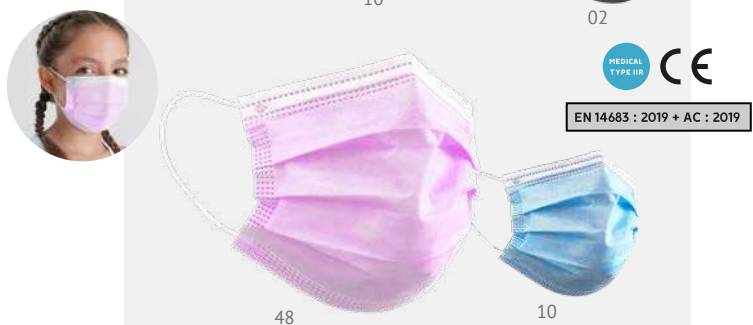

PRESTON5_ 9928

Mascarilla médica desechable (Quirúrgica TIPO I). Triple capa con acabados termosellados, elásticos de sujeción y clip nasal ajustable. Presentada en bolsa de 5 uds.

 17,5 x 9,5 cm  5/50  2000

Consultar Precio



PRESTON_ 9927

Mascarilla médica desechable (Quirúrgica TIPO I). Triple capa con acabados termosellados, elásticos de sujeción y clip nasal ajustable.

 17,5 x 9,5 cm  50  2000

Consultar Precio



MASCARILLAS HIGIÉNICAS REUTILIZABLES

UNE
0065:2020

TEJIDO
ANTIBACTERIANO

REUTILIZABLE
25 LAVADOS

COSTURA CONFORT
INVISIBLE

TALLA INFANTIL
Y ADULTO

HIDRÓFUGA
TRANSPIRABLE



BLANCO SUBLIMABLE

01

02

56

30

23

57



02

01

60

05

55

226

63

48

NEW

MENDEL_ 9917

Mascarilla higiénica transpirable e hidrófuga. Antibacteriana con costura confort invisible. Tejido interior 100% algodón.

11,5 x 14,5 cm 10 500

E(1), N(8), R

HARVEY_ 9926

Mascarilla higiénica reutilizable de 2 capas. Realizada en tejido no tejido y microfibra antibacteriana, transpirable e hidrófuga. Amplio surtido de colores y apta para personalización.

11,5 x 14,5 cm 10 500

E(1), N(8)



PERSONALIZABLE 100%

MADE TO ORDER

Crea tu propio diseño 100% personalizado

PEDIDO MÍNIMO
25 UDS

ENTREGA 15 DÍAS
para mascarillas personalizadas

CHRISTMAS

248/251

Un toque de distinción.

Los mejores regalos navideños
para las fiestas de fin de año.





01

226

05

60

31

SANTA_ 1300

Gorro navideño de Papá Noel realizado en suave poliéster. Talla única.

 43 x 30 cm

 10

 200

 D(1), N(8)
**NOEL_ 1301**

Calcetín navideño con tira para colgar. Realizado en suave poliéster.

 34 x 22 cm

 10

 200

 D(1), N(8)

JINGLE_ 1305

Adorno navideño de madera. Disponible en dos diseños: estrella y árbol. Incluyen cinta roja para colgar en el árbol de Navidad.

9,5 x 10 x 0,5 cm 50 400

C(4), L1



512



511

MADERA NATURAL



514

512

513

ABEND_ 1302

Adorno navideño de fieltro. Disponible en tres diseños: Copo de nieve, Árbol de Navidad y Reno.

10,1 x 8,3 x 0,3 cm 100 500

C(1)

SET ADORNOS 3 PIEZAS

CAROL_ 1310

Set de 3 adornos navideños de fieltro: Estrella, Árbol y Reno. Para colgar en árbol de Navidad.

10 x 10 cm 100 500

C(1)



AROMA VAINILLA



PIZARRA

KING_ 1307

Vela aromática con portavelas pizarra de cerámica. Incluye tiza blanca. Presentación en caja diseño eco.

7,8 x Ø7 cm 1 50

E(1), L2





SIN AFILAR

515

516

512

KLAUS_ 1304

Imán navideño con diseño de Papa Noel. Incluye bloc de notas con 50 hojas lisas y lápiz de madera.

10 x 20 cm

50

200

C(2)



CERAS INCLUIDAS

RENO_ 1308

Calcetín con diseño navideño para colorear. Incluye 5 ceras de colores variados. Realizado en non-woven de 80 g/m².

29,5 x 19 cm

1

200

F(1)



01



60



40



31



05



03



02



226

FLAKE_ 1306

Vela aromática en vivos colores presentada a juego con portavelas metálico. Tapa con ventana transparente.

3 x Ø6,3 cm

50

250

E(1), L1

índice numérico

REFERENCIA PÁGINA

0100	190	3020	61	4007	149	4068	155	7101	219	7532	221	8014	80	8100	213
0101	191	3021	56	4008	148	4070	179	7102	218	7533	221	8015	81, 239	8101	212
0102	191	3022	09, 57	4010	148	4071	179	7103	220	7534	22, 122	8016	82	8102	211
0103	190	3023	08, 62	4011	166	4072	179	7104	217	7535	22, 123	8017	82	8103	213
0104	187	3024	09, 57	4012	32, 150	4073	180	7105	217	7537	113, 233	8018	12, 76	8104	210
0105	189	3025	46	4013	32, 150	4074	179	7111	110	7538	29, 129	8019	13, 76	8110	195, 211
0106	189	3026	11, 46	4014	142, 196	4075	178	7112	111	7539	29, 129	8020	94	8150	224
0107	188	3050	65	4015	146	4076	178	7113	110	7540	29, 129	8021	82	8151	232
0108	189	3051	65	4016	34, 152	4077	155	7114	108, 193	7541	29, 129	8022	73, 238	8200	101, 232
0109	188	3052	64	4017	34, 153	4078	31, 177	7116	111	7542	117	8023	84, 187	8201	101, 232
0110	188	3053	61	4018	34, 152	4079	183	7117	111	7543	123	8024	84, 186	8202	225
0111	183	3054	60	4019	34, 153	4080	181, 207	7118	217	7544	23, 117	8025	74	8203	240
0112	183	3100	202	4020	30, 162	4081	30, 154	7119	220	7545	15, 116	8026	74	9001	217
1003	224	3101	206	4021	159	4082	145	7124	102	7546	15, 85, 116	8027	74	9003	195, 202
1006	225	3102	195, 202	4022	33, 151	4083	144	7137	26, 104	7547	23, 112, 234	8028	73	9004	139, 195
101	228	3103	207	4023	159	4084	142	7138	98	7548	100	8029	18, 75	9006	202
1220	230	3105	206	4024	149	4085	149	7145	102	7549	23, 122	8030	17, 81	9009	139
1221	230	3106	206	4025	171	4086	159	7146	98	7550	23, 105	8031	12, 73	9128	157
1222	231	3110	203	4026	171	4087	32, 177	7150	106	7551	26, 126	8032	17, 78	9129	156
1223	230	3111	203	4027	171	4088	177	7151	109	7552	27, 125	8033	19, 83	9130	156
1225	228	3150	45	4028	170	4089	180, 243	7152	106, 193	7553	27, 124	8034	12, 76	9131	118, 158, 182
1226	231	3151	45	4029	170	4186	67	7153	103	7554	27, 124	8035	16, 71	9132	157
1227	231	3200	43	4031	170	4187	67	7154	103, 192	7555	24, 128	8036	13, 77	9133	158
1228	185, 231	3201	42	4032	31, 161	4188	67	7155	108	7556	25, 128	8037	19, 83	9133	158
1229	184, 231	3202	43	4033	31, 161	5601	137	7157	107	7557	25, 104	8038	72, 239	9904	244
1230	228	3203	41	4034	165	5602	35, 137	7158	103	7558	24, 113, 233	8039	72, 239	9905	243
1300	249	3203	41	4035	31, 160	5606	136, 194	7501	120	7559	85, 100	8040	71, 239	9906	245
1301	249	3204	41	4036	174	5607	135	7502	120	7560	24, 113	8042	18, 75	9907	245
1302	250	3205	42, 59	4037	164	5608	135, 194	7503	120	7561	28, 128	8043	14, 75	9908	245
1303	251	3206	08, 40	4038	173	5609	134, 194	7504	120	7601	26, 126	8044	14, 77	9915	246
1304	251	3207	10, 40	4039	169, 197	5610	35, 136	7506	119	7602	127	8045	70	9916	243
1305	250	3208	07, 38	4040	163, 197	5621	138	7509	109	7603	130, 223	8046	86, 239	9917	247
1306	184, 251	3209	06, 38	4041	167	5622	138	7510	102	7604	130, 223	8047	182	9919	245
1307	185, 250	3210	10, 39	4042	166	5623	138	7511	115, 235, 242	7605	130, 223	8048	19, 83	9920	242
1308	251	3300	48	4043	167	7000	214	7512	115, 235	7606	28, 131, 222	8049	87	9921	243
1310	250	3301	48	4044	172	7008	216	7513	114, 235	7607	28, 131, 222	8050	91	9923	24, 229
2009	139	3302	49	4045	168, 197	7012	216	7514	114, 235	8000	87	8051	91	9924	229
2100	44	3303	49	4046	175	7013	205	7515	99	8001	87	8052	93	9925	246
2150	224	3304	48	4047	175	7019	215	7516	99, 200	8002	86	8053	21, 89	9926	247
3000	60	3305	47	4048	160, 197	7020	216	7517	99	8003	86, 187	8054	93	9927	246
3002	60	3307	47	4049	168, 197	7041	215	7518	100	8004	80	8055	21, 89	9928	246
3003	59	3350	55	4050	180	7050	214	7519	125	8005	80	8056	88	9929	241
3005	58	3351	53	4051	181	7051	242	7520	26, 126	8006	79	8057	88	9930	246
3006	53, 63	3352	54	4052	180, 243	7052	201	7521	127	8007	74	8058	95	9932	241
3007	63	3353	55	4053	181	7053	195, 201	7522	121, 193	8008	78	8059	95	9933	246
3008	62	3355	11, 52	4054	181	7054	200	7523	121	8009	72	8060	91, 238	9934	245
3009	62	3400	51	4055	162	7055	201	7524	121	8010	70	8061	91, 238	9935	115
3011	64, 195	3401	50	4057	32, 155	7056	242	7525	27, 125	8011	79	8062	88	9936	139, 240
3012	65	3402	51	4058	169	7060	204	7526	109	8012	79	8063	88	9938	220, 240
3013	63, 101	4000	143, 196	4060	142, 196	7061	205	7527	119, 193	8013	81	8064	87	9939	242
3014	63, 101	4001	143, 196	4061	30, 154	7062	205	7528	118	8070	20, 89	8070	20, 89	9940	241
3015	61	4003	143, 196	4062	33, 151	7063	204	7529	118, 182	8071	20, 90	8071	20, 90		
3017	94	4004	168	4063	33, 151	7070	200	7530	118, 182	8072	20, 90	8072	20, 90		
3018	10, 58	4005	147	4064	152	7097	219	7531	221	8073	21, 92	8073	21, 92		
3019	11, 62	4006	147	4065	33, 151	7100	220			8074	21, 92	8074	21, 92		

índice alfabético

ARTÍCULO	PÁGINA		PÁGINA
A		D	
Abanicos	203	Delantales	156, 157, 158, 182
Abridores	31, 177, 178, 179	E	
Adaptadores de corriente	63	Espejos	230
Adornos de navidad	250	Esterilla de yoga	218
Agendas	95	Estuches	15, 85, 116
Ajustador mascarillas	242	F	
Alfombrilla de ratón	64, 65, 94, 195	Fiambreras	184, 185, 250, 251
Almohadillas de viaje	232	Flexómetros	189
Altavoz cargador	06, 38, 42, 59	Funda de gafas	211
Altavoces inalámbricos	06, 07, 08, 10, 38, 39, 40, 41, 42, 43	Funda porta mascarillas	240
Anti estrés	184, 185, 231	Funda soporte para móvil	61
Aplaudidores	206	G	
Auriculares	11, 45, 46, 47, 48, 49	Gafas de sol	210, 211, 212, 213
Auriculares inalámbricos	11, 45, 46, 47, 48, 49	Gafas de seguridad	243
B		Geles hidroalcohólicos	244, 245
Balón	224	Gorras	139
Baterías Externas	11, 52, 53, 54, 55	Gorro	139
Batería Externa Inalámbrica	55	Gorro de navidad	249
Bálsamos	228	Guante táctil	138
Banderines	207	I	
Bastoms	206	Identificadores	200
Bidones	162, 163, 164, 165, 166, 167, 168, 169, 172, 173, 174, 175, 197	Imán porta notas	251
Bidones de cristal	30, 162, 163, 164	L	
Bidones para sublimación	163, 168, 169, 197	Lanyards	195, 200, 201
Bloc de notas	20, 21, 89, 90, 91	Lanyards	242
Bloc de notas Anti bacterias	91, 238	Portamascarillas	
Bolígrafos	70, 71, 72, 73, 74, 75, 76, 77, 78, 79, 80, 81, 82, 83, 84	Lápices	86, 87, 187, 239
Bolígrafos Anti bacterias	71, 72, 73, 81, 238, 239	Lápiz de navidad	251
Bolígrafos con puntero	13, 16, 74, 76, 79, 80, 81	Lápices de colores	87
Bolígrafo linterna	84, 187	Libretas	89, 92, 93
Bolígrafo marcador	19, 83	Linternas	188
Bolígrafos multiherramientas	84, 186, 187	Llavero Anti contacto	180, 243
Bolígrafo spray	73, 238	Llaveros	179, 180, 181, 183, 207
Bolsas	22, 23119, 120, 121, 122, 123, 124, 125, 126, 127, 128, 129, 182, 193	Lupa Cuentahilos	187
Bolsas algodón	25, 26, 27, 124, 125, 126, 127, 128	M	
Bolsas de papel	28, 29, 128, 129	Mano animación	206
Bolsas de yute	128	Manoplas	157
Bolsas estancas	221	Mantas	138
Bolsas para deporte	110, 111	Máscaras faciales	243
Bolsas para sublimación	193	Máscara de viaje	232
Bolsas plegables	193	Mascarillas	246, 247
Bolsas RPET	93	Memorias USB	67
Braga Gorro	139	Mini Libretas	93
Bragas polares	139, 195, 240	Mochila RPET	23, 105
C		Mochilas	98, 102, 103, 104, 105, 106, 107, 108, 109, 110, 182, 192, 193
Cámara deportiva	44	Mochilas algodón	25, 26, 104
Calcetines de navidad	249, 251	Mochilas nevera	130
Calendarios	94	Mochilas plegables	116, 118
Cargador soporte	56, 57, 60, 63	Monederos	15, 23, 116, 117
Cargador USB de coche	60	Mosquetón	180
Cargadores inalámbricos	07, 09, 10, 56, 57, 58, 59, 60	Muñequera	217
Cargadores Llavero 3 en 1	62, 63	N	
Cepillo con espejo	230	Neceseres	24, 112, 113, 114, 115, 233, 234, 235
Cepillos de dientes	229	Neveras	28, 130, 131, 222, 223
Ceras de colores	87	O	
Cinta cabeza deportiva	217	Organizador cargador	09, 57
Cintas para sombrero	205	P	
Chanclas	224	Pajitas	155, 159
Cubrevolante	190	Palas de playa	224
Cutters	189	Pañoletas	195, 202
		Paraguas	35, 134, 135, 136, 194
		Paraguas plegables	35, 136
		Paraguas RPET	35, 136
		Parasoles	190, 191
		Pastilleros	231
		Pizarra magnética	182
		Ponchos impermeables	35, 137
		Porta notas adhesivas	88
		Portadocumentos	200
		Portadocumentos de viaje	99, 100
		Portamascarillas	240, 241, 242
		Portatodo	225
		Posavasos	32, 177
		Pulseras	195, 202
		Puzzle	183
		R	
		Ratones Inalámbricos	64, 65
		Relojes Inteligentes	50, 51
		Riñoneras	100, 217
		Rollers	82
		S	
		Sacacorchos	178
		Set adornos de navidad	250
		Set Bandas elásticas	219
		Set Cargadores usb	60
		Set de cocina infantil	158
		Set Escritura	77, 87
		Set Pajita / Tenedor	159
		Set de viaje	115, 244
		Silbato	206
		Sombreros	204, 205
		Sombrilla de playa	225
		Soporte para Smartphone	61, 63
		T	
		Tangram	183
		Tapa Webcam	65
		Tazas	30, 32, 33, 34, 142, 143, 144, 145, 146, 147, 148, 149, 150, 151, 152, 154, 171, 196
		Tazas para sublimación	142, 143, 149, 196
		Termos	31, 160, 161
		Toallas	219, 220, 240
		Toallita higienizante	245
		U	
		USB HUB	08, 62
		V	
		Vasos	32, 33, 34, 151, 152, 153, 155, 161, 170, 251
		Velas	184, 185, 250, 251
		Y	
		Yoyó	183
		Z	
		Zapatillas	232

CÓDIGO COLOR

01	Blanco	116	Rojo Vino	56	Verde Botella	252	Rosetón Vigoré	990	Kiwi
011	Blanco Perla	48	Rosa Claro	20	Verde Kelly	253	Morado Vigoré	991	Baloncesto
58	Gris	34	Rosa Chicle	216	Verde Tropical	246	Turquesa Vigoré	992	Futbol
251	Plata	72	Frambuesa	17	Verde Lab	248	Royal Vigoré	993	Tenis
260	Oro	78	Rosetón	13	Verde Kaki	255	Azul Dénim Vigoré	995	Cebra
23	Plomo	40	Fucsia	15	Verde Militar	247	Azul Marino Vigoré	996	Pollo
231	Ébano	230	Orquidea	38	Verde Militar Oscuro	980	Verde Menta Vigoré	997	Jirafa
59	Gris Oscuro	63	Morado	118	Lima Limón	257	Verde Botella Vigoré	998	Pez
46	Plomo Oscuro	71	Púrpura	69	Verde Mantis	153	Verde Militar Oscuro Vigoré	999	Bambú
02	Negro	126	Azul Lavado	28	Pistacho	693	Verde Mantis Vigoré	511	Estrella
29	Crudo	10	Celeste	225	Lima	250	Lima Vigoré	512	Árbol
229	Angora	12	Turquesa	235	Lima Punch	135	Verde Helecho Vigoré	513	Reno
07	Arena	43	Azul Profundo	114	Verde Oasis	249	Amarillo Flúor Vigoré	514	Copo
85	Camel	100	Azul Océano	24	Verde Irish	244	Coral Flúor Vigoré	515	Noel
219	Arena Oscura	05	Royal	83	Verde Grass	222	Verde Flúor	516	Snowman
67	Nogal	99	Azul Eléctrico	226	Verde Helecho	221	Amarillo Flúor	981	Rectangular
87	Chocolate	65	Azulina	450	Marrón	223	Naranja Flúor	982	Round
36	Amarillo Cãñamo	86	Azul Dénim	013	Blanco Vigoré	228	Rosa Flúor	983	Oval
03	Amarillo	44	Azul Lab	259	Gris Claro Vigoré	125	Rosa lady Flúor	88	Wood
96	Amarillo Golden	55	Azul Marino	237	Ébano Vigoré	234	Coral flúor	157	Spain
30	Mostaza	98	Verde Menta	243	Negro Vigoré	84	Fresa	158	France
31	Naranja	041	Verde Marea	39	Mostaza Vigoré	985	Limón	161	Italy
311	Naranja Bemellón	236	Aguamarina	310	Naranja Vigoré	986	Manzaba	162	Portugal
60	Rojo	45	Azul Luz de Luna	245	Rojo Vigoré	987	Tomate		
64	Borgoña	217	Verde Jungla	238	Borgoña Vigoré	988	Uva		
57	Granate	124	Verde Senda	256	Granate Vigoré	989	Piña		

iconografía

-  CAJAS
-  PACK
-  MEDIDAS
-  TÉCNICAS DE IMPRESIÓN
-  RESISTENTE AL AGUA
-  MODELO IMPERMEABLE
-  A PRUEBA DE VIENTO
-  MODELO TRANSPIRABLE
-  TEJIDO TÉCNICO
-  ETIQUETA REMOVIBLE
-  KIDS PARA NIÑO
-  ALIMENTACIÓN

-  TECNOLOGÍA BLUETOOTH
-  FUNCIÓN ALTAVOZ
-  CARGA INALÁMBRICA
-  RADIO INTEGRADA
-  LECTOR TARJETA MICRO SD
-  CONEXIÓN LINE IN
-  REPRODUCTOR USB
-  MANOS LIBRES
-  CONTADOR DE PULSACIONES
-  CONTADOR DE CALORÍAS
-  CONTADOR DE PASOS
-  CONTROL DEL SUEÑO
-  CRONÓMETRO
-  DISPONE DE APLICACIÓN
-  NOTIFICACIONES DE APLICACIÓN
-  TRANSMISIÓN DE DATOS
-  RESISTENTE AL AGUA
-  FIBRA DE BAMBÚ
-  FIBRA DE TRIGO
-  USB
-  TIPO C
-  MICRO USB
-  LIGHTNING
-  ARTÍCULO REPETIDO
-  RESISTENTE AL VIENTO
-  CEMENTO
-  LIGHT
-  CORCHO NATURAL
-  DIÁMETRO PARAGUAS

Técnicas de marcaje

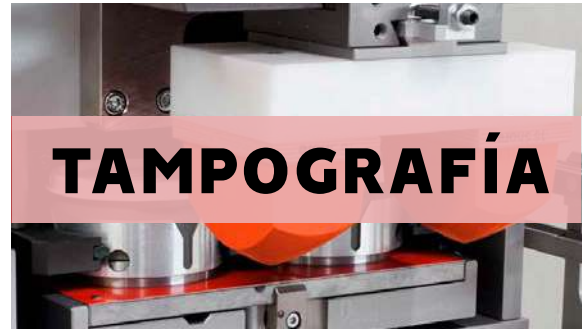
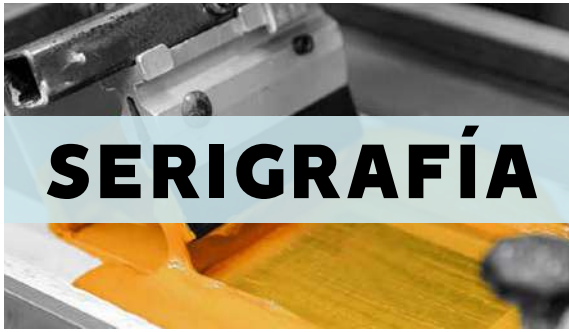

Código de marcaje	Técnica
A - K	Tampografía - Serigrafía
M	Cuatricomía
N	Transfer serigráfico
O	Transfer digital
Q	Sublimación tazas

R	Sublimación
T	Termo grabado
U	Termo grabado con cinta color
W	Impresión digital
P	Bordado
L	Láser

Nos reservamos el derecho a modificar sin notificación previa los códigos de impresión y/o número de colores publicados en este catálogo.



LONGAN_ 4031



PEFC™
PEFC/14-38-00040

Certificado PEFC

Impreso en papel que
procede de bosques
gestionados de forma
sostenible y fuentes
controladas

www.pefc.es

